

COMPLEX REFLECTION GROUPS AND K3 SURFACES II. THE GROUPS G_{29} , G_{30} AND G_{31}

CÉDRIC BONNAFÉ AND ALESSANDRA SARTI

ABSTRACT. We study some K3 surfaces obtained as minimal resolutions of quotients of subgroups of special reflection groups. Some of these were already studied in a previous paper by W. Barth and the second author. We give here an easy proof that these are K3 surfaces, give equations in weighted projective space and describe their geometry.

1. INTRODUCTION

In the first paper of this series [5], the authors have explained how to build K3 surfaces from invariants of complex reflection groups of rank 4 generated by reflections of order 2. In this second part and the upcoming third part [6], we complete this qualitative result by investigating more precisely the examples given by the primitive groups (see [5, §2] for the definition), i.e. the groups G_{28} , G_{29} , G_{30} and G_{31} (as in [5], we follow Shephard-Todd numbering for complex reflection groups [25]). In particular, we investigate the following questions:

- (a) We show that all the K3 surfaces constructed this way have big Picard number compared to the number of moduli of the family they belong to.
- (b) We compute some of the transcendental lattices of those K3 surfaces with Picard number 20.
- (c) We give some explicit equations in weighted projective space.
- (d) We construct explicit elliptic fibrations for all the examples of K3 surfaces we obtain: as shown in [27, Corollary 2.7] there is only a finite number of elliptic fibrations for a K3 surfaces (up to automorphism) but, even though we sometimes construct several non-equivalent elliptic fibrations, there is no case in which we pretend to have constructed all of them. For some of them, we determine the singular fibers. When one knows the transcendental lattice one could use the recent paper by Festi and Veniani [13] to compute the number of elliptic fibrations (up to automorphism of the surface).

In this second paper, we focus on the groups G_{29} , G_{30} and G_{31} while the third paper [6] will be devoted to the study of G_{28} . See the introduction of [6] for the reasons why G_{28} deserves a particular treatment, we recall here the main points : firstly, $G'_{28} \neq G_{28}^{\text{SL}}$; secondly, there are two possible interesting degrees for the fundamental invariants, namely 6 and 8; thirdly, G_{28} admits an interesting outer automorphism. Also, we take opportunity of this work to revisit results from both

Date: December 22, 2021.

The first author is partly supported by the ANR: project No. ANR-16-CE40-0010-01 (GeRep-Mod) and ANR-18-CE40-0024-02 (CATORE)

The second author is partly supported by the ANR: project No. ANR-20-CE40-0026-01 (SMAGP).

authors who constructed highly singular surfaces from invariants of complex reflection groups [21], [3]. Most (but not all) of the singularities constructed this way can be obtained from [5, Corollary 2.4]. In §6.5, we also revisit Boissière-Sarti example of the smooth octic surface containing 352 lines [2], using Springer theory [5, Theorem 3.13].

Finally, note that the first part [5] was free of computer calculations, as the arguments were pretty general: in this second part, we study very specific examples, for which the determination of geometric features (singularities, transcendental lattices, branch locus, etc.) requires computer calculations. We use here the software MAGMA [9] (as well as some specific functions described in [4]).

The structure of the paper is as follows. In section 3 we recall some general facts on the groups G_{29} , G_{30} and G_{31} . The section 4 is devoted to the group G_{29} . Here we consider the unique G_{29} -invariant polynomial of degree four which defines a quartic K3 surface in $\mathbb{P}^3(\mathbb{C})$, this is denoted by X_{Mu} in [8]. We consider then the quotient of the quartic K3 surface by the derived group $G'_{29} = G_{29}^{\text{SL}}$. As remarked in [8] we have that $\mathbb{P}G'_{29} = M_{20}$ the Mathieu group, which acts symplectically on X_{Mu} . It is well known that the minimal resolution is again a K3 surface and Xiao in [31] showed that the Picard number is 20. We give in Lemma 4.1 and Corollary 4.2 an alternative proof that uses Lehrer-Springer theory. In §4.3 we describe an elliptic fibration on this surface and thanks to that we compute the transcendental lattice. This result is new and summarized in the following theorem:

Theorem 1.1. *Let \tilde{X}^{29} be the minimal resolution of X_{Mu}/G'_{29} . This is a K3 surface with Picard number 20 admitting an elliptic fibration with fibers $\tilde{E}_6 + \tilde{D}_6 + 2\tilde{A}_2 + \tilde{A}_1$ and transcendental lattice isometric to*

$$\mathbf{T}_{\tilde{X}^{29}} = \begin{pmatrix} 6 & 0 \\ 0 & 60 \end{pmatrix}.$$

Observe that this surface was already studied under a different point of view by M. Schütt in the paper [23, Table 2] about the construction of elliptic fibrations on extremal K3 surfaces. Note that Schütt constructs another elliptic fibration for \tilde{X}^{29} : it would be interesting to know if there are still other elliptic fibrations. In section 5 we consider the group G_{30} and the zero set of the one dimensional family of invariant polynomials of degree 12. The group G_{30} is the Coxeter group of type H_4 . Let \tilde{X}_λ^{30} denote the K3 surface which is the minimal resolution of the quotient of the zero set $Z(f_{2,\lambda})$ of the polynomials of degree 12 by G_{30}^{SL} and let X_λ^{30} denotes this singular quotient (recall that here $G'_{30} = G_{30}^{\text{SL}}$). In [1], [22] the Picard number and the transcendental lattice of the K3 surfaces were computed. The equation of X_λ^{30} and the description of the elliptic fibration is new. We show the following result :

Theorem 1.2. *We have the following equation*

$$X_\lambda^{30} = \{[y_1 : y_3 : y_4 : j] \in \mathbb{P}(1, 2, 3, 6) \mid j^2 = r_\lambda(y_1, y_3, y_4)\}$$

where $r_\lambda(y_1, y_3, y_4)$ is a polynomial of total degree 12. For λ generic the surface \tilde{X}_λ^{30} has Picard number 19 and it admits an elliptic fibration with fibers $\tilde{D}_5 + \tilde{A}_4 + 2\tilde{A}_2 + 3\tilde{A}_1$. The transcendental lattice as computed in [22] is

$$\mathbf{T}_{\tilde{X}_\lambda^{30}} = \begin{pmatrix} 4 & 2 & 0 \\ 2 & 34 & 0 \\ 0 & 0 & -30 \end{pmatrix}.$$

There are at least four special values of λ for which the Picard number of the corresponding K3 surface is 20, these four values correspond to the surfaces in $Z(f_{2,\lambda})$ that have isolated ADE singularities. These values of λ , the singular fibers of an elliptic fibration and the transcendental lattices are resumed in Table 5.4

Finally section 6 is devoted to the group G_{31} and the one-dimensional family of invariant polynomials of degree 20. We have again $G_{31}^{\text{SL}} = G'_{31}$, let X_λ^{31} denote the singular quotient by G_{31}^{SL} and by \tilde{X}_λ^{31} its minimal resolution. The latter is a K3 surface and we show

Theorem 1.3. *We have the following equation*

$$X_\lambda^{31} = \{[y_1 : y_2 : y_4 : j] \in \mathbb{P}(2, 1, 2, 5) \mid j^2 = q_\lambda(y_1, y_2, y_4)\}.$$

where $q_\lambda(y_1, y_2, y_4)$ is a polynomial of total degree 10. For λ generic the surface \tilde{X}_λ^{31} has Picard number 18 and it admits an elliptic fibration with singular fibers $\tilde{D}_7 + 3\tilde{A}_2 + 3\tilde{A}_1$. There are at least six special values of λ for which the Picard number of the corresponding K3 surface is 19, five of these values correspond to the singular fibers in $Z(f_{3,\lambda})$. These values of λ and the singular fibers of an elliptic fibration are resumed in Table 7.3

Finally in the Appendix we collect several useful results that allow to find the equations of the K3 surfaces and the elliptic fibrations. We remark that in the case of G_{31} we described a one parameter family of K3 surfaces, we believe that this family is not isotrivial, but we could not prove it, for G_{30} this was shown in [1].

Acknowledgements: We warmly thank A. Degtyarev and B. Naskręcki for useful comments on X_{Mu} and X. Roulleau for explaining us how to use the Artin-Tate conjecture to compute the Picard number in Theorem 1.3 and for useful comments. The first author is grateful to the MSRI to let him use its high performance computing facilities.

Hypothesis and notation. We keep the notation introduced in [5]. We recall some of them. First, V is a complex vector space and W is a complex reflection group acting on V of dimension n . If $v \in V \setminus \{0\}$, we denote by $[v] \in \mathbb{P}(V)$ the line it defines (i.e. $[v] = \mathbb{C}v$). If S is a subset of V , we denote by W_S (resp. $W(S)$) the setwise (resp. pointwise) stabilizer of S (so that $W(S)$ is a normal subgroup of W_S and $W_S/W(S)$ acts faithfully on S). The derived subgroup of W will be denoted by W' , and we set $W^{\text{SL}} = W \cap \mathbf{SL}_{\mathbb{C}}(V)$. The degrees (resp. codegrees) of W (see [5, §3.1]) are denoted by (d_1, d_2, \dots, d_n) and $(d_1^*, d_2^*, \dots, d_n^*)$ respectively.

If $e \in \mathbb{Z}_{\geq 1}$, we set

$$\delta(e) = |\{1 \leq k \leq n \mid e \text{ divides } d_k\}| \quad \text{and} \quad \delta^*(e) = |\{1 \leq k \leq n \mid e \text{ divides } d_k^*\}|.$$

With this notation, we have

$$\delta(e) = \max_{w \in W} (\dim V(w, \zeta_e)).$$

In particular, ζ_e is an eigenvalue of some element of W if and only if $\delta(e) \neq 0$ that is, if and only if e divides some degree of W . In this case, we fix an element w_e of W such that

$$\dim V(w_e, \zeta_e) = \delta(e).$$

We set for simplification $V(e) = V(w_e, \zeta_e)$ and $W(e) = W_{V(e)}/W(V(e))$: this subquotient of W acts faithfully on $V(e)$.

However, from now on, and until the end of this paper, we assume that $n = \dim(V) = 4$ and that $W \subset \mathbf{GL}_{\mathbb{C}}(V)$ is a primitive¹ complex reflection group. If S is a K3 surface, we denote by \mathbf{T}_S its transcendental lattice and by $\rho(S)$ its Picard number.

If C_1, \dots, C_r are curves on a surface S , the *intersection graph* will be represented as follows: vertices correspond to C_1, \dots, C_r and are represented by circles (with no information if self-intersection is -2 ; otherwise, the self-intersection number is written inside the circle) and there is an edge between the vertices corresponding to C_j and $C_{j'}$ if $C_j \cdot C_{j'} \neq 0$ (nothing more is written on the edge if $C_j \cdot C_{j'} = 1$; otherwise, the number $C_j \cdot C_{j'}$ is written above the edge).

The singular fibers of elliptic fibrations will be denoted as usual according to their intersection matrix: for instance, a singular fiber of type \tilde{D}_4 is a fiber whose intersection matrix is the Cartan matrix of the extended Dynkin diagram of type \tilde{D}_4 (in Kodaira's notation, it is of type I_0^*). There remain some ambiguities (for types \tilde{A}_1 and \tilde{A}_2): we say that a singular fiber is of type \tilde{A}_1 (resp. \tilde{A}_2) if it is of type I_2 (resp. I_3) and will use Kodaira's notation (i.e. III or IV) for the other singular fibers whose intersection graph is of type \tilde{A}_1 or \tilde{A}_2 .

If S is a K3 surface and $\varphi : S \rightarrow \mathbb{P}^1(\mathbb{C})$ is an elliptic fibration admitting a section $\sigma : \mathbb{P}^1(\mathbb{C}) \rightarrow S$, we denote by $\text{MW}_{\sigma}(\varphi)$ (or simply $\text{MW}(\varphi)$ if σ is clear from the context) its Mordell-Weil group. In this case, we denote by $\text{Triv}_{\sigma}(\varphi)$ (or $\text{Triv}(\varphi)$) the *trivial lattice* of the fibration φ , namely the lattice generated by the vertical divisors and the class of the image of σ . Then

$$(1.4) \quad \text{MW}_{\sigma}(\varphi) \simeq \text{Pic}(S)/\text{Triv}_{\sigma}(\varphi).$$

See the book [24] for more details on elliptic surfaces.

We will often denote by $\begin{pmatrix} a & b \\ c & \end{pmatrix}$ the 2×2 -matrix:

$$\begin{pmatrix} a & b \\ b & c \end{pmatrix}.$$

2. PRELIMINARIES ON PRIMITIVE COMPLEX REFLECTION GROUPS OF RANK 4

Recall [25] that there are five primitive complex reflection groups of rank 4, and that they are denoted by G_{28} , G_{29} , G_{30} , G_{31} and G_{32} . The first four are generated by reflections of order 2 and G_{32} is generated by reflections of order 3. Note that G_{28} (resp. G_{30}) is the Coxeter group of type F_4 (resp. H_4).

When we do explicit computations, we use the models of the primitive complex reflection groups W that were implemented in MAGMA by the first author (almost copying files due to Michel [17] and Thiel [28]) in a file

`primitive-complex-reflection-groups.m`

which can be downloaded in [4]. Most of them (but not all) are taken from [17] or [28]. We do not pretend that these are the best models, but the interested reader might have a look at [3, Remark 1.3] for a discussion about some of the advantages of these models.

Representing W as a subgroup of $\mathbf{GL}_4(\mathbb{C})$ allows to identify V with \mathbb{C}^4 and we denote by (x, y, z, t) the dual basis of the canonical basis of \mathbb{C}^4 . Therefore, $\mathbb{C}[V] = \mathbb{C}[x, y, z, t]$.

¹Recall that W is said *primitive* if there does not exist a decomposition $V = V_1 \oplus \dots \oplus V_r$ with $r \geq 2$ and $V_k \neq 0$ such that W permutes the V_k 's

| W | $ W $ | $ W/Z(W) $ | $ W' $ | Deg(W) Codeg(W) |
|-------------------|--------|------------|--------|--------------------------------|
| G_{29} | 7 680 | 1 920 | 3 840 | 4, 8, 12, 20 0, 8, 12, 16 |
| $G_{30} = W(H_4)$ | 14 400 | 7 200 | 7 200 | 2, 12, 20, 30 0, 10, 18, 28 |
| G_{31} | 46 080 | 11 520 | 23 040 | 8, 12, 20, 24 0, 12, 16, 28 |

TABLE I. Numerical informations for G_{29} , G_{30} and G_{31}

A first advantage of the chosen models is that the group W is implemented as a Galois stable subgroup of $\mathbf{GL}_4(K)$ where K is a finite Galois extension of \mathbb{Q} (the fact that such a model always exists was proved by Marin-Michel [16]). This implies that we can find fundamental invariants in $\mathbb{Q}[x, y, z, t]$. For instance, with such a model for $W = G_{30} = W(H_4)$, the singular dodecic surfaces constructed by the second author [21] can be realized over \mathbb{Q} , as explained in [3, Proposition 1.1].

Another advantage of our models is that W generally contains a big subgroup of monomial matrices (except for $W = G_{30} = W(H_4)$). This leads to expressions of fundamental invariants in terms of symmetric functions. For this reason, we introduce the following notation: if m is a monomial in x, y, z, t , we denote by $\Sigma(m)$ the sum of the monomials obtained by permuting the variables. For instance,

$$\Sigma(x^4y) = x^4(y + z + t) + y^4(x + z + t) + z^4(x + y + t) + t^4(x + y + z) = \Sigma(xy^4).$$

3. THE GROUPS G_{29} , G_{30} AND G_{31}

Hypothesis. *From now on, and until the end of this paper, we assume moreover that W is one of the three primitive groups G_{29} , G_{30} or G_{31} .*

Let us first recall in Table I some specific data for these three groups that were contained in [5, Table I].

Note that the hypothesis implies that

$$W' = W^{\text{SL}}$$

is of index 2 in W (recall from [5] the notation $W^{\text{SL}} = W \cap \mathbf{SL}_{\mathbb{C}}(V)$): we denote by σ the non-trivial element of W/W' . According to [5, Theorem 5.4], the surface $\mathcal{L}(f)/W'$ is a K3 surface with ADE singularities (endowed with a non-symplectic automorphism given by the action of σ), provided that f is a fundamental invariant of W of degree 4 if $W = G_{29}$, of degree 12 if $W = G_{30}$ or of degree 20 if $W = G_{31}$ such that $\mathcal{L}(f)$ has only ADE singularities (which is almost always the case²). Our aim in this paper is to study the geometry of the K3 surface with ADE singularities

²This is not true only for the one-parameter family of surfaces of degree 20 built from G_{31} : in this family, only one surface does not have ADE singularities (it is in fact reducible). See Section 6 for details.

| W | d | $\mathcal{L}_{\text{sing}}(f)$ | m | singularities of $\mathcal{Z}(f)/W'$ | ρ | $\mathbf{T}_{\widetilde{\mathcal{Z}(f)/W'}}$ |
|----------|-----|--------------------------------|-----|--------------------------------------|-----------|--|
| G_{29} | 4 | \emptyset | 0 | $D_4 + 2A_4 + 3A_2 + A_1$ | 20 | $(6 \ 0 \ 60)$ |
| G_{30} | 12 | \emptyset | 1 | $A_4 + 4A_2 + 5A_1$ | ≥ 19 | Theorem 1.2 |
| | | $60A_1$ | 0 | $E_8 + 3A_2 + 4A_1$ | 20 | $(4 \ 2 \ 34)$ |
| | | $300A_1$ | 0 | $E_6 + A_4 + 2A_2 + 4A_1$ | 20 | $(12 \ 6 \ 58)$ |
| | | $360A_1$ | 0 | $D_7 + 4A_2 + 3A_1$ | 20 | $(6 \ 0 \ 132)$ |
| | | $600A_1$ | 0 | $D_5 + A_4 + 3A_2 + 3A_1$ | 20 | $(6 \ 0 \ 220)$ |
| G_{31} | 20 | \emptyset | 1 | $D_6 + A_3 + 3A_2 + 2A_1$ | ≥ 18 | |
| | | $960A_1$ | 0 | $D_6 + D_5 + A_3 + 2A_2$ | 19 | |
| | | $480A_1$ | 0 | $E_6 + D_6 + A_3 + A_2 + A_1$ | 19 | |
| | | $1920A_1$ | 0 | $D_6 + A_5 + A_3 + A_2 + 2A_1$ | 19 | |
| | | $1440A_2$ | 0 | $D_6 + D_5 + 3A_2 + A_1$ | 19 | |
| | | $640A_3$ | 0 | $D_6 + 2A_3 + 2A_2 + 2A_1$ | 19 | |

(Here, $d = \deg(f)$, m is the number of moduli of the family and $\rho = \rho(\widetilde{\mathcal{Z}(f)/W'})$)

TABLE II. K3 surfaces of the form $\widetilde{\mathcal{Z}(f)/W'}$ for $W = G_{29}$, G_{30} or G_{31}

$\mathcal{Z}(f)/W'$ and of its minimal resolution $\widetilde{\mathcal{Z}(f)/W'}$: in particular, we prove that the informations given in Table II are correct³.

4. THE GROUP G_{29}

Hypothesis. *We assume in this section, and only in this section, that $W = G_{29}$.*

³Erratum: the singularities of the five singular surfaces of degree 20 defined by fundamental invariants of G_{31} given in Table II differ from the ones given in [3, Table 4]: in fact, there is a mistake in [3], as can be checked with MAGMA thanks to [4], and the correct values are given in Table II. See the correction statement at <https://doi.org/10.1080/10586458.2018.1555778>.

We have $G_{29} = \langle s_1, s_2, s_3, s_4 \rangle$, where

$$s_1 = \begin{pmatrix} 1 & 0 & 0 & 0 \\ 0 & 1 & 0 & 0 \\ 0 & 0 & 1 & 0 \\ 0 & 0 & 0 & -1 \end{pmatrix}, \quad s_2 = \frac{1}{2} \begin{pmatrix} 1 & 1 & i & i \\ 1 & 1 & -i & -i \\ -i & i & 1 & -1 \\ -i & i & -1 & 1 \end{pmatrix},$$

$$s_3 = \begin{pmatrix} 0 & 1 & 0 & 0 \\ 1 & 0 & 0 & 0 \\ 0 & 0 & 1 & 0 \\ 0 & 0 & 0 & 1 \end{pmatrix}, \quad s_4 = \begin{pmatrix} 1 & 0 & 0 & 0 \\ 0 & 0 & 1 & 0 \\ 0 & 1 & 0 & 0 \\ 0 & 0 & 0 & 1 \end{pmatrix}.$$

Recall that $i = \zeta_4$, a primitive fourth root of unity. Some of the numerical facts used below can be extracted from [5, Table I]. For instance, note that $G_{29}^{\text{SL}} = G'_{29}$ is of index 2 in G_{29} , so that $G_{29} = \langle s_1 \rangle \times G'_{29}$ (observe that s_1 is an involution). Note also that $Z(G_{29}) \simeq \mu_4 \subset G'_{29}$, see for instance [5, (3.2)]. Moreover, $PG'_{29} \simeq M_{20}$ (the Mathieu group of degree 20) so that we have a split exact sequence

$$1 \longrightarrow PG'_{29} \simeq M_{20} \longrightarrow PG_{29} \longrightarrow \mu_2 \longrightarrow 1,$$

where the last map is induced by the determinant.

4.1. The K3 surface. By [5, Table I], there exists a unique (up to scalar) homogeneous invariant polynomial f_1 of degree 4: it is given by

$$f_1 = \Sigma(x^4) - 6\Sigma(x^2y^2).$$

As in [8], we set $X_{\text{Mu}} = \mathcal{Z}(f)$ (recall that this surface was discovered by Mukai [18]). It can easily be checked that X_{Mu} is a smooth and irreducible quartic in $\mathbb{P}^3(\mathbb{C})$, so that it is a K3 surface, endowed with a symplectic action of M_{20} and an extra non-symplectic automorphism of order 2. Several properties of X_{Mu} are given in [8] (transcendental lattice, automorphisms, polarizations: note that it is denoted by X_{Mu} in [8], as it was discovered by Mukai [18]). For instance, it is known that X_{Mu} has Picard number 20.

Continuing with the topic of this paper, we describe here geometric properties of the quotient $X^{29} = X_{\text{Mu}}/G'_{29}$: as the quotient of a K3 surface by a finite group acting symplectically, it is also a K3 surface with ADE singularity, whose minimal resolution \tilde{X}^{29} has Picard number 20 (see [8]). This can also be proved by examining the singularities of X^{29} , which are given below:

Lemma 4.1 (Xiao). *The K3 surface X^{29} has singularities $D_4 + 2A_4 + 3A_2 + A_1$.*

Proof. See [31, Table 2, last line]. As we need concrete results (for instance, the coordinates of the singular points), we provide a proof that will provide these extra-informations.

Since the action of PG'_{29} on X_{Mu} is symplectic, it is sufficient to compute the stabilizers of points of X_{Mu} . For this, we follow the discussion of [5, §4.1], from which we keep the notation. We fix $v \in V \setminus \{0\}$ such that $z = [v] \in X_{\text{Mu}}$ and we may assume that $W_z = W_v \langle w_{e_z} \rangle$. Note that 4 divides e_z because $w_4 = \zeta_4 \text{Id}_V \in W$, and that e_z divides one of the degrees of W . So $e_z \in \{4, 8, 12, 20\}$. This leads to

the following discussion (the MAGMA codes relative to the computations mentioned below are available at [7, §4.1]):

- If $e_z = 20$ then, since $\delta(20) = \delta^*(20) = 1$, we have $W_v = 1$ by [5, Theorem 3.13] and $\det(w_{20}) = \zeta_{20}^{4+8+12+20-4} = 1$. So the stabilizer of z in W is contained in W' : so the W -orbit of z contains two W' -orbits, and the stabilizer of z in PG'_{29} is cyclic of order 5. This leads to $2A_4$ singularities in X^{29} , which we denote by a_4^\pm .
- If $e_z = 12$, then $\delta(12) = 1$, so the W -orbit of z is completely determined, and a computation with MAGMA shows that $|W_z| = 24$. This shows that W_v is generated by a single reflection and so $W'_z = \langle w_{12} \rangle \subsetneq W_z$. So the W -orbit of z is a single W' -orbit, and the stabilizer of z in PG'_{29} is cyclic of order 3. This leads to an A_2 singularity in X^{29} , which we denote by a_2 .
- If $e_z = 8$, then $\delta(8) = 1$, so the W -orbit of z is completely determined, and a computation with MAGMA shows that $|W_z| = 64 \neq 32 = |W'_z|$. So the W -orbit of z is a single W' -orbit, and one checks with MAGMA that the stabilizer of z in PG'_{29} is the quaternionic group of order 8. This leads to a D_4 singularity in X^{29} , which we denote by d_4 .
- Assume now that $e_z = 4$. If $|W_v| = 1$ or 2 , then $W'_z = \langle w_4 \rangle$ and so the stabilizer of z in PG'_{29} is trivial. So the image of z in X^{29} is smooth. By [5, Corollary 2.4], the group W_v cannot have rank 3, for otherwise z would be singular in X_{Mu} . So W_v has rank 2. There are three conjugacy classes of parabolic subgroups of rank 2 (see [7, §4.1]), and representatives are given by

$$W_{12} = \langle s_1, s_2 \rangle, \quad W_{13} = \langle s_1, s_3 \rangle \quad \text{and} \quad W_{23} = \langle s_2, s_3 \rangle.$$

We denote by L_{jk} the projective line $\mathbb{P}(V^{W_{jk}})$ in $\mathbb{P}(V)$. Since X_{Mu} is smooth, it follows that L_{jk} meets X_{Mu} transversally [5, Corollary 2.8], and we set $E_{jk} = L_{jk} \cap X_{\text{Mu}}$. Then $|E_{jk}| = 4$ and it follows from [5, §sub:stab, (c)] that two elements of Ω_{jk} are in the same W' -orbit if and only if they are in the same $(W' \cap N_{jk})$ -orbit. Now the next results can be obtained with MAGMA:

- The group W_{12} is of type A_2 and $|(W' \cap N_{12})/W_{12}\langle w_4 \rangle| = 2$. Moreover, the stabilizer of any point in E_{12} is equal to $(W' \cap W_{12})\langle w_4 \rangle$, so its stabilizer in PW' is cyclic of order 3. This leads to $2A_2$ singularities in X^{29} , which we denote by a_2^\pm .
- The group W_{13} is of type $A_1 \times A_1$ and $|(W' \cap N_{13})/W_{13}\langle w_4 \rangle| = 4$. Moreover, the stabilizer of any point in E_{13} is equal to $(W' \cap W_{13})\langle w_4 \rangle$, so its stabilizer in PW' is cyclic of order 2. This leads to an A_1 singularities in X^{29} , which we denote by a_1 .
- The set E_{23} is contained in the W -orbit of z_8 , so this case has already been treated and does not lead to new singularities in X^{29} .

The proof of the proposition is complete. \square

Corollary 4.2. *The Picard number of the K3 surface \tilde{X}^{29} is 20.*

Proof. As \tilde{X}^{29} is algebraic, we get from Lemma 4.1 that the rank of $\text{Pic}(\tilde{X}^{29})$ is

$$\geq 1 + (1 + 3 \cdot 2 + 2 \cdot 4 + 4) = 20.$$

Since this rank is bounded above by 20 for a K3 surface, this yields the result. \square

Remark 4.3. With a suitable choice of a family \mathbf{f} of fundamental invariants and a suitable normalization of J , one gets [7, §4.2] with MAGMA that

$$\begin{aligned} X^{29} &= \{[x_2 : x_3 : x_4 : j] \in \mathbb{P}(2, 3, 5, 10) \mid \\ j^2 &= -64x_2^5x_4^2 + 16x_2^4x_3^4 + 32x_2^3x_3^3x_4 + 1800x_2^2x_3^2x_4^2 \\ &\quad - 432x_2x_3^6 - 5000x_2x_3x_4^3 + 432x_3^5x_4 + 3125x_4^4 \} \end{aligned}$$

(see [5, Proposition 3.11]). In this model, the singular points are given as follows [7, §4.4]:

$$\begin{aligned} d_4 &= [1 : 0 : 0 : 0], & a_2 &= [0 : 1 : 0 : 0], & a_4^\pm &= [0 : 0 : 1 : \pm 25\sqrt{5}] \\ a_1 &= [\alpha : \beta : 1 : 0] & \text{and} & & a_2^\pm &= [\alpha_\pm : \beta_\pm : 1 : 0], \end{aligned}$$

where

$$\begin{cases} (\alpha^5, \alpha\beta, \beta^5) = (84375/16, -25/2, 3125/54), \\ (\alpha_\pm^5, \alpha_\pm\beta_\pm, \beta_\pm^5) = ((3987 \pm 1632\sqrt{6})/16, (7 \pm 2\sqrt{6})/2, (117 \pm 62\sqrt{6})/18). \end{cases}$$

Indeed, it follows from [5, Lemma 2.2] that d_4 , a_2 and a_4^\pm have coordinates of the form $[1 : 0 : 0 : j_1]$, $[0 : 1 : 0 : j_2]$ and $[0 : 0 : 1 : j_3^\pm]$ respectively, and the values of j_1 , j_2 and j_3^\pm are determined by the equation of X^{29} .

For the remaining points, computations with MAGMA [7, §4.4] show that the evaluation of f_4 (the invariant of degree 20) at points of E_{12} or E_{13} is different from 0, so that the points a_1 and a_2^\pm belong to the affine chart $X_{(4)}^{29}$ of X^{29} defined by $x_4 \neq 0$. Setting $x_4 = 1$, the coordinates in the ambient space of $X_{(4)}^{29}$ are $a = x_2^5$, $b = x_2x_3$, $c = x_3^5$ and j , and $X_{(4)}^{29}$ is equal to

$$\begin{aligned} X_{(4)}^{29} &= \{(a, b, c, j) \in \mathbb{A}^4(\mathbb{C}) \mid b^5 = ac \text{ and} \\ j^2 &= -64a + 16b^4 + 32b^3 + 1800b^2 - 432bc - 5000b + 432c + 3125\}. \end{aligned}$$

From the second equation, we can express a in terms of b , c and j , and so

$$(4.4) \quad X_{(4)}^{29} = \{(b, c, j) \in \mathbb{A}^3(\mathbb{C}) \mid 64b^5 = cP_{29}(b, c, j)\},$$

where $P_{29}(b, c, j) = 16b^4 + 32b^3 + 1800b^2 - 432bc - 5000b + 432c + 3125 - j^2$. The coordinates of the singular points of $X_{(4)}^{29}$ can then be computed with MAGMA and fit with what is written above [7, §4.4].

Finally, recall that the action of the non-trivial element σ of W/W' is given by

$$(4.5) \quad \sigma \cdot [x_2 : x_3 : x_4 : j] = [x_2 : x_3 : x_4 : -j]$$

that $X/\langle \sigma \rangle \simeq \mathbb{P}(2, 3, 5)$. \blacksquare

4.2. Some smooth rational curves in X^{29} . We work in the model given by Remark 4.3 and we denote by $\pi : \tilde{X}^{29} \rightarrow X^{29}$ the natural morphism from the minimal resolution \tilde{X}^{29} of X^{29} . If p is a singular point of X^{29} , we denote by $\Delta_1^p, \dots, \Delta_m^p$ the irreducible components of $\pi^{-1}(p)$ (these are smooth rational curves and m is equal to the Milnor number of X^{29} at p). We define

$$C_2 = \{[x_2 : x_3 : x_4 : j] \in X^{29} \mid x_2 = 0\}$$

and

$$C_3 = \{[x_2 : x_3 : x_4 : j] \in X^{29} \mid x_3 = 0\}.$$

Let \tilde{C}_2 and \tilde{C}_3 denote the respective strict transforms of C_2 and C_3 in \tilde{X}^{29} .

Proposition 4.6. *The curves C_2 and C_3 are smooth rational curves.*

Proof. First,

$$C_3 = \{[x_2 : x_4 : j] \in \mathbb{P}(2, 5, 10) \mid j^2 = -64x_2^5x_4^2 + 3125x_4^4\}.$$

But the map $\mathbb{P}(2, 5, 10) \rightarrow \mathbb{P}^2(\mathbb{C})$, $[x_2, x_4, j] \mapsto [x_2^5, x_4^2, j]$ is an isomorphism of varieties. Through this isomorphism, we get

$$C_3 = \{[x_2 : x_4 : j] \in \mathbb{P}^2(\mathbb{C}) \mid j^2 = -64x_2x_4 + 3125x_4^2\}.$$

Hence, C_3 is a non-degenerate conic in $\mathbb{P}^2(\mathbb{C})$, i.e. C_3 is a smooth rational curve.

For C_2 , note that

$$C_2 = \{[x_3 : x_4 : j] \in \mathbb{P}(3, 5, 10) \mid j^2 = 432x_3^5x_4 + 3125x_4^4\}.$$

But $\mathbb{P}(3, 5, 10) \simeq \mathbb{P}(3, 1, 2)$ and, through this isomorphism, one gets

$$C_2 = \{[x_3 : x_4 : j] \in \mathbb{P}(3, 1, 2) \mid j^2 = 432x_3x_4 + 3125x_4^4\}.$$

For $k \in \{3, 4\}$, we denote by $C_2^{(k)}$ the affine chart of C_2 defined by $x_k \neq 0$. Then $C_2 = C_2^{(3)} \cup C_2^{(4)}$ and we only need to show that $C_2^{(3)}$ and $C_2^{(4)}$ are smooth rational affine curves. For $C_2^{(4)}$, this is obvious. For $C_2^{(3)}$, working with the coordinates $a = x_4^3$, $b = x_4j$ and $c = j^3$, one gets

$$\begin{aligned} C_2^{(3)} &= \{(a, b, c) \in \mathbb{A}^3(\mathbb{C}) \mid b^3 = ac, c = 432b + 3125ab \text{ and } b^2 = 432a + 3125a^2\} \\ &\simeq \{(a, b) \in \mathbb{A}^2(\mathbb{C}) \mid b^2 = 432a + 3125a^2\}. \end{aligned}$$

This is clearly smooth and the result follows. \square

Proposition 4.6 implies that \tilde{C}_2 and \tilde{C}_3 are smooth rational curves in \tilde{X}^{29} . Adding the 19 smooth rational curves of the form Δ_m^p , this gives us 21 smooth rational curves in \tilde{X}^{29} , we investigate in the next subsection if these curves are independent in the Picard group or not.

4.3. An elliptic fibration. Any K3 surface with Picard number 20 admits an elliptic fibration. We construct here an explicit one, and determine its singular fibers.

First, let $\varphi : X^{29} \setminus \{a_4^+, a_4^-\} \rightarrow \mathbb{P}^1(\mathbb{C})$, $[x_2 : x_3 : x_4 : j] \mapsto [x_2^3 : x_3^2]$. This map is indeed well-defined on $X^{29} \setminus \{a_4^+, a_4^-\}$ and induces a map

$$\tilde{\varphi} : \tilde{X}^{29} \setminus (\pi^{-1}(a_4^+) \cup \pi^{-1}(a_4^-)) \longrightarrow \mathbb{P}^1(\mathbb{C}).$$

Our elliptic fibration is obtained by extending $\tilde{\varphi}$:

Proposition 4.7. *The map $\tilde{\varphi} : \tilde{X}^{29} \setminus (\pi^{-1}(a_4^+) \cup \pi^{-1}(a_4^-)) \longrightarrow \mathbb{P}^1(\mathbb{C})$ extends to a morphism of algebraic varieties $\tilde{X}^{29} \longrightarrow \mathbb{P}^1(\mathbb{C})$.*

Proof. Let $\hat{\pi} : \hat{X}^{29} \longrightarrow X^{29}$ denote the minimal resolution of X^{29} only at the points a_4^+ and a_4^- . In particular, \hat{X}^{29} is still singular (it has singularities $A_1 + 3A_2 + D_4$). Let $\hat{\varphi} = \varphi \circ \hat{\pi} : \hat{X}^{29} \setminus (\hat{\pi}^{-1}(a_4^+) \cup \hat{\pi}^{-1}(a_4^-)) \longrightarrow \mathbb{P}^1(\mathbb{C})$. Since the resolution $\pi : \tilde{X}^{29} \rightarrow X^{29}$ factors through \hat{X}^{29} , it is sufficient to show that $\hat{\varphi}$ extends to \hat{X}^{29} .

We will now use the results (and the notation) of Appendix A with $(k, l) = (2, 3)$. Let $a_4 = [0 : 0 : 1] \in \mathbb{P}(2, 3, 5)$: it is the image of a_4^+ (or a_4^-) through the quotient morphism $X^{29} \longrightarrow \mathbb{P}(2, 3, 5)$. Now, the map $\varphi : X^{29} \setminus \{a_4^+, a_4^-\} \rightarrow \mathbb{P}^1(\mathbb{C})$ is the composition of the quotient $X^{29} \setminus \{a_4^+, a_4^-\} \longrightarrow \mathbb{P}(2, 3, 5) \setminus \{a_4\}$ and the map $\varphi_{2,3} : \mathbb{P}(2, 3, 5) \setminus \{a_4\} \longrightarrow \mathbb{P}^1(\mathbb{C})$ defined in Appendix A. Therefore, $\hat{\varphi}$ is the composition

$$\hat{X}^{29} \setminus (\hat{\pi}^{-1}(a_4^+) \cup \hat{\pi}^{-1}(a_4^-)) \longrightarrow \hat{\mathbb{P}}(2, 3, 5) \setminus \{a_4\} \xrightarrow{\hat{\varphi}_{2,3}} \mathbb{P}^1(\mathbb{C}),$$

where the first map is the quotient by the lift of σ . So the result follows from the fact that $\hat{\varphi}_{2,3}$ extends to $\hat{\mathbb{P}}(2, 3, 5)$ (see (A.1)). \square

Remark 4.8. Let us describe two sections of the elliptic fibration $\tilde{\varphi}$. For this, keep the notation \hat{X}^{29} , $\hat{\varphi}$ of the proof of Proposition 4.7. The map $\hat{\varphi}$ factors through

$$\hat{X}^{29} \longrightarrow \hat{\mathbb{P}}(2, 3, 5) \xrightarrow{\hat{\varphi}_{2,3}} \mathbb{P}^1(\mathbb{C}),$$

the first map being the quotient by the action of σ . We denote by $\Delta_1, \dots, \Delta_4$ the smooth rational curves defined in Appendix A and by $\hat{\Delta}_1^{a_4^\pm}, \dots, \hat{\Delta}_4^{a_4^\pm}$ the smooth rational curves of the exceptional divisor of \hat{X}^{29} above a_4^\pm . Since $X^{29} \longrightarrow \mathbb{P}(2, 3, 5)$ is unramified above $[0 : 0 : 1]$, we can number those last curves so that $\hat{\Delta}_j^{a_4^\pm} \rightarrow \Delta_j$ is an isomorphism.

Now, by Remark A.4, the map $\hat{\varphi}_{2,3}$ admits a section $\theta : \mathbb{P}^1(\mathbb{C}) \longrightarrow \hat{\mathbb{P}}(2, 3, 5)$ whose image is Δ_2 . This yields two sections $\hat{\theta}^\pm : \mathbb{P}^1(\mathbb{C}) \rightarrow \hat{X}^{29}$, whose image is $\Delta_2^{a_4^\pm}$. Now, \tilde{X}^{29} is obtained from \hat{X}^{29} by successive blow-ups of points not lying in $\Delta_2^{a_4^+} \cup \Delta_2^{a_4^-}$, so $\hat{\theta}^\pm$ lifts to a section $\tilde{\theta}^\pm : \mathbb{P}^1(\mathbb{C}) \longrightarrow \tilde{X}^{29}$, note that $\tilde{\theta}^- = \sigma \circ \tilde{\theta}^+$. \blacksquare

Let $[u : v] \in \mathbb{P}^1(\mathbb{C})$. We denote by $X_{u,v}^{29}$ the Zariski closure of $\varphi^{-1}([u : v])$ (endowed with its reduced structure) in X^{29} and by $\tilde{X}_{u,v}^{29}$ its strict transform in \tilde{X}^{29} . Note that $\tilde{X}_{u,v}^{29} \subset \tilde{\varphi}^{-1}([u : v])$ and that

$$\begin{aligned} X_{u,v}^{29} &= \left(\{[x_2 : x_3 : x_4 : j] \in X \mid vx_2^3 = ux_3^2\} \right)_{\text{red}} \\ &= \varphi^{-1}([u : v]) \cup \{a_4^+, a_4^-\}, \end{aligned}$$

where Y_{red} denotes the reduced subscheme of Y (this is necessary only if $uv = 0$).

Corollary 4.9. *The elliptic fibration $\tilde{\varphi}$ has singular fibers $\tilde{E}_6 + \tilde{D}_6 + 2\tilde{A}_2 + \tilde{A}_1$.*

Proof. Since the map $\tilde{\varphi}$ factorizes through the quotient $\tilde{X}^{29}/\langle\sigma\rangle$, it follows from Proposition A.3 that the intersection graph of the family of smooth rational curves $(\tilde{C}_2, \tilde{C}_3, \Delta_1^{a_4^+}, \Delta_2^{a_4^+}, \Delta_3^{a_4^+}, \Delta_4^{a_4^+}, \Delta_1^{a_4^-}, \Delta_2^{a_4^-}, \Delta_3^{a_4^-}, \Delta_4^{a_4^-})$ is given by

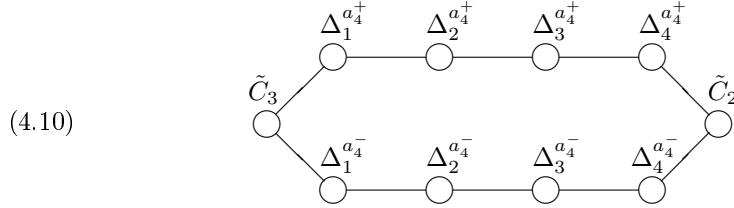

Moreover, Proposition A.3 also shows that $\Delta_1^{a_4^+}$ and $\Delta_1^{a_4^-}$ (resp. $\Delta_3^{a_4^+}, \Delta_4^{a_4^+}, \Delta_3^{a_4^-}$ and $\Delta_4^{a_4^-}$) are the only rational curves among the $\Delta_k^{a_4^\pm}$'s which are contained in $\tilde{\varphi}^{-1}([1 : 0])$ (resp. $\tilde{\varphi}^{-1}([0 : 1])$).

This shows that $\tilde{\varphi}^{-1}([1 : 0])$ and $\tilde{\varphi}^{-1}([0 : 1])$ are singular fibers. Let us determine their type. Note that

$$C_3 = X_{1,0}^{29} \quad \text{and} \quad C_2 = X_{0,1}^{29}.$$

As the only singular points of \tilde{X}^{29} belonging to C_3 (resp. C_2) are a_4^+, a_4^- and d_4 (resp. a_4^+, a_4^- and a_2), this shows that

$$\tilde{\varphi}^{-1}([1 : 0]) = \tilde{C}_3 \cup \Delta_1^{a_4^+} \cup \Delta_1^{a_4^-} \cup \left(\bigcup_{k=1}^4 \Delta_k^{d_4} \right)$$

and
$$\tilde{\varphi}^{-1}([0 : 1]) = \tilde{C}_2 \cup \left(\bigcup_{k=3}^4 (\Delta_k^{a_4^+} \cup \Delta_k^{a_4^-}) \right) \cup \left(\bigcup_{k=1}^2 \Delta_k^{a_2} \right).$$

But $\Delta_k^{a_4^\pm} \cdot \Delta_l^{d_4} = \Delta_k^{a_4^\pm} \cdot \Delta_m^{a_2} = 0$, so the Kodaira-Néron classification of singular fibers forces that, with a suitable numbering of the $\Delta_k^{d_4}$'s and the $\Delta_k^{a_2}$'s, the intersection graphs inside $\tilde{\varphi}^{-1}([1 : 0])$ and $\tilde{\varphi}^{-1}([0 : 1])$ are respectively given by

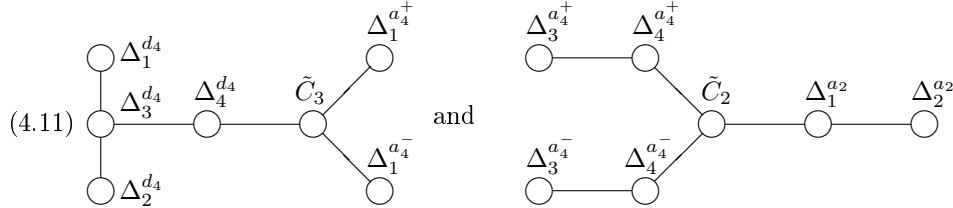

In other words, they are of type \tilde{D}_6 and \tilde{E}_6 respectively.

Let us now study the fibers of $\tilde{\varphi}$ at $[\alpha^3 : \beta^2]$ and $[\alpha_{\pm}^3 : \beta_{\pm}^2]$, where $\alpha, \beta, \alpha_{\pm}$ and β_{\pm} are defined in Remark 4.3. This amounts to understand the fibers of φ passing through a_1, a_2^+ and a_2^- . Let us first determine their irreducible components (we treat only the cases of a_1 and a_2^+ , as the case of a_2^- is isomorphic to the case of a_2^+). Note that

$$\frac{\beta^2}{\alpha^3} = \frac{\beta^5}{(\alpha\beta)^3} = \frac{4}{135} \quad \text{and} \quad \frac{\beta_+^2}{\alpha_+^3} = \frac{\beta_+^5}{(\alpha_+\beta_+)^3} = \frac{-36 + 16\sqrt{6}}{45}.$$

Working inside the affine chart $X_{(4)}^{29}$, a MAGMA computation [7, §4.4] shows that a_1 (resp. a_2^+) is an A_1 -singularity of $X_{135,4}^{29}$ (resp. $X_{45,-36+16\sqrt{6}}^{29}$). In particular, the projective tangent cone of $X_{135,4}^{29}$ (resp. $X_{45,-36+16\sqrt{6}}^{29}$) at a_1 (resp. a_2^+) consists in two points, so $\hat{X}_{135,4}^{29}$ (resp. $\hat{X}_{45,-36+16\sqrt{6}}^{29}$) meets $\Delta_1^{a_1}$ (resp. $\Delta_1^{a_2^+} \cup \Delta_2^{a_2^+}$) in two points. Moreover, again by using MAGMA computations [7, §4.4], we can check that $\tilde{X}_{135,4}^{29}$ and $\tilde{X}_{45,-36+16\sqrt{6}}^{29}$ are irreducible of genus 0. This shows that $\tilde{\varphi}^{-1}([135 : 4]) = \tilde{X}_{135,4}^{29} \cup \Delta_1^{a_1}$ (resp. $\tilde{\varphi}^{-1}([45 : -36 + 16\sqrt{6}]) = \tilde{X}_{45,-36+16\sqrt{6}}^{29} \cup \Delta_1^{a_2^+} \cup \Delta_2^{a_2^+}$) is a singular fiber of type \tilde{A}_1 (resp. \tilde{A}_2).

So we have found that the elliptic fibration $\tilde{\varphi}$ has at least 5 singular fibers of respective types $\tilde{A}_1, \tilde{A}_2, \tilde{A}_2, \tilde{D}_6$ and \tilde{E}_6 . Since the sum of the Euler characteristic of these singular fibers is equal to 24, the elliptic fibration $\tilde{\varphi}$ has no more singular fiber. \square

4.4. Transcendental lattice. We aim to prove that $\text{Pic}(\tilde{X}^{29})$ is generated by the classes of the 21 smooth rational curves described in the previous subsection. The intersection numbers between these 21 smooth rational curves have been determined in the proof of Corollary 4.9 (see (4.10) and (4.11)). They are gathered in the following proposition.

Proposition 4.12. *The intersection graph of the above 21 smooth rational curves is given by*

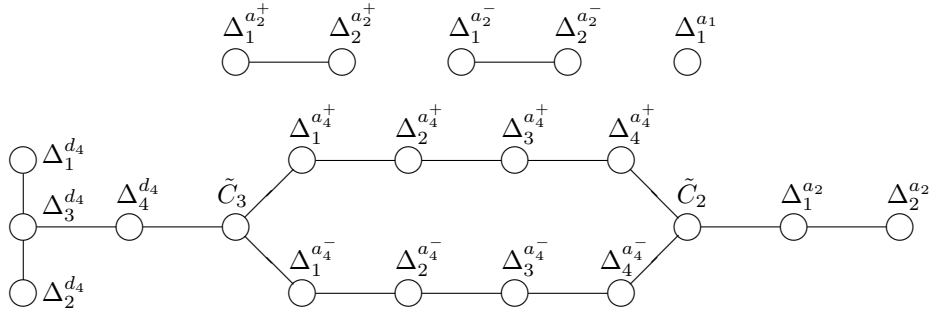

We can then compute the lattices $\text{Pic}(\tilde{X}^{29})$ and $\mathbf{T}_{\tilde{X}^{29}}$

Theorem 4.13. *The Picard group $\text{Pic}(\tilde{X}^{29})$ admits*

$$([\Delta_1^{a_2^+}], [\Delta_2^{a_2^+}], [\Delta_1^{a_2^-}], [\Delta_2^{a_2^-}], [\Delta_1^{a_1}], [\Delta_1^{d_4}], [\Delta_2^{d_4}], [\Delta_3^{d_4}], [\Delta_4^{d_4}], [\tilde{C}_3], \\ [\Delta_1^{a_4^+}], [\Delta_2^{a_4^+}], [\Delta_3^{a_4^+}], [\Delta_4^{a_4^+}], [\Delta_1^{a_4^-}], [\Delta_2^{a_4^-}], [\Delta_3^{a_4^-}], [\Delta_4^{a_4^-}], [\tilde{C}_2], [\Delta_1^{a_2}])$$

as a \mathbb{Z} -basis. The transcendental lattice of \tilde{X}^{29} is given by

$$\mathbf{T}_{\tilde{X}^{29}} = \begin{pmatrix} 6 & 0 \\ 0 & 60 \end{pmatrix}.$$

Proof. Let us denote by $(D_1, D_2, \dots, D_{20})$ the elements written in the statement of the theorem, in the same order. Let $I^\circ = (D_j \cdot D_k)_{1 \leq j, k \leq 20}$. Then $\det(I^\circ) = -360$ (see [7, §4.7]). This shows that the family $(D_k)_{1 \leq k \leq 20}$ is \mathbb{Z} -free and, as $\rho(\tilde{X}^{29}) = 20$ by Corollary 4.2, this shows that $(D_k)_{1 \leq k \leq 20}$ is a \mathbb{Q} -basis of $\text{Pic}(\tilde{X}^{29}) \otimes \mathbb{Q}$. We denote by Λ the sublattice of $\text{Pic}(\tilde{X}^{29})$ generated by $(D_k)_{1 \leq k \leq 20}$. Its dual lattice Λ^\vee in $\text{Pic}(\tilde{X}^{29}) \otimes \mathbb{Q}$ satisfies $|\Lambda^\vee/\Lambda| = \det(I^\circ) = 360$ and $\Lambda \subset \text{Pic}(\tilde{X}^{29}) \subset \Lambda^\vee$.

Let m denote the order of $\text{Pic}(\tilde{X}^{29})/\Lambda$. We must show that $m = 1$. Assume that there exists a prime number p dividing m . Then m^2 divides $|\Lambda^\vee/\Lambda|$, so $p \in \{2, 3\}$.

Assume first that 2 divides m . Then $\text{Pic}(\tilde{X}^{29})/\Lambda$ contains an element of order 2 and a computation with MAGMA shows that this implies that $\text{Pic}(\tilde{X}^{29})$ contains one of the elements

$$\frac{1}{2}D_5 = \frac{1}{2}[\Delta_1^{a_1}], \quad \frac{1}{2}(D_6 + D_7) = \frac{1}{2}([\Delta_1^{d_4}] + [\Delta_2^{d_4}]) \quad \text{or} \quad \frac{1}{2}(D_5 + D_6 + D_7)$$

(see [7, §4.7]). But any element D in this list satisfies $D \cdot D \notin 2\mathbb{Z}$: this contradicts the fact that $\text{Pic}(\tilde{X}^{29})$ is an even lattice. So m is not divisible by 2.

Assume finally that 3 divides m . Then $\text{Pic}(\tilde{X}^{29})/\Lambda$ contains an element of order 3 and a computation with MAGMA shows that this implies that $\text{Pic}(\tilde{X}^{29})$ contains one of the elements

$$L_{a,b} = \frac{a}{3}(D_1 - D_2) + \frac{b}{3}(D_3 - D_4) = \frac{a}{3}([\Delta_1^{a_2^+}] - [\Delta_2^{a_2^+}]) + \frac{b}{3}([\Delta_1^{a_2^-}] - [\Delta_2^{a_2^-}])$$

for some $a, b \in \{0, 1, 2\}$ and $(a, b) \neq (0, 0)$ (see [7, §4.7]). But $L_{a,b} \cdot L_{a,b} = 2/3(a^2 + b^2) \notin \mathbb{Z}$, so we also get a contradiction. This shows that m is not divisible by 3. Consequently, $m = 1$, as expected.

Let us now turn to the computation of the transcendental lattice of \tilde{X}^{29} . First, as there is a finite rational map $X_{\text{Mu}} \dashrightarrow \tilde{X}^{29}$, the transcendental lattice of \tilde{X}^{29} is proportional (by some rational number) to the one of X_{Mu} by [14, Proposition 1.1]. But the transcendental lattice of X_{Mu} is given by

$$\mathbf{T}_{X_{\text{Mu}}} = \begin{pmatrix} 4 & 0 \\ 0 & 40 \end{pmatrix}$$

(see for instance [8, Proposition 4.4(1)]). As the discriminant of $\mathbf{T}_{\tilde{X}^{29}}$ is equal to the discriminant of $\text{Pic}(\tilde{X}^{29})$, this shows that $\text{disc}(\mathbf{T}_{\tilde{X}^{29}}) = 360$, and so the only possibility is

$$\mathbf{T}_{\tilde{X}^{29}} = \begin{pmatrix} 6 & 0 \\ 0 & 60 \end{pmatrix},$$

as expected. \square

Remark 4.14. Note that one can write

$$\begin{aligned} [\Delta_2^{a_2}] &= [\Delta_1^{d_4}] + [\Delta_2^{d_4}] + 2[\Delta_3^{d_4}] + 2[\Delta_4^{d_4}] + 2[\tilde{C}_3] + [\Delta_1^{a_4^+}] + [\Delta_1^{a_4^-}] \\ &\quad - [\Delta_3^{a_4^+}] - [\Delta_3^{a_4^-}] - 2[\Delta_3^{a_4^+}] - 2[\Delta_3^{a_4^-}] - 3[\tilde{C}_2] - 2[\Delta_1^{a_2}]. \blacksquare \end{aligned}$$

We conclude this section by determining the Mordell-Weil group of $\tilde{\varphi}$, with respect to the section $\tilde{\theta}^+$:

Proposition 4.15. $\text{MW}_{\tilde{\theta}^+}(\tilde{\varphi}) = \mathbb{Z}[\Delta_2^{a_4^-}] \simeq \mathbb{Z}$.

Proof. First, it follows from [26, Nr. 2493] that the torsion group of $\text{MW}_{\tilde{\theta}^+}(\tilde{\varphi})$ is trivial. By the description of the singular fibers of the fibration $\tilde{\varphi}$ given in Corollary 4.9, the rank of the group $\text{Triv}_{\tilde{\theta}^+}(\tilde{\varphi})$ is equal to 19. Hence $\text{MW}_{\tilde{\theta}^+}(\tilde{\varphi}) \simeq \mathbb{Z}$. To determine the generators, one just needs to notice that $\text{Pic}(\tilde{X}^{29})$ is generated by all the classes given in Theorem 4.13 while $\text{Triv}_{\tilde{\theta}^+}(\tilde{\varphi})$ is generated by all these classes except $[\Delta_2^{a_4^-}]$ (see Remark 4.14) and we fix $\Delta_2^{a_4^+}$ as the zero section of the fibration. \square

4.5. Complements: conics in X_{Mu} . As explained in [8, Proposition 4.3], the K3 surface X_{Mu} is the Kummer surface of the abelian surface $\mathcal{E}_{i\sqrt{10}} \times \mathcal{E}_{i\sqrt{10}}$, where \mathcal{E}_α denotes the elliptic curve $\mathbb{C}/(\mathbb{Z} \oplus \mathbb{Z}\alpha)$. Therefore, there exists a Nikulin configuration in X_{Mu} (i.e., 16 two by two disjoint smooth rational curves). Since [8] appeared, it has been shown by Degtyarev [11, Theorem 1.1 and Introduction] that X_{Mu} contains 800 irreducible conics (note that 320 conics were already found in [8, Remark 4.4] but this set of conics contains no Nikulin configuration). Later, Naskręcki found explicit equations for the 800 conics, and showed that one can extract from this set a Nikulin configuration, [19]. Let us describe them here. For this, let

$$C_0 = \left\{ [x : y : z : t] \in \mathbb{P}^3(\mathbb{C}) \mid z + i\frac{1 + \sqrt{5}}{2}t = x^2 + 2\sqrt{2}xy + y^2 + 3\frac{1 + \sqrt{5}}{2}t^2 = 0 \right\},$$

$$C_1 = \left\{ [x : y : z : t] \in \mathbb{P}^3(\mathbb{C}) \mid x + y + z = y^2 + yz + z^2 + \frac{3 + \sqrt{10}}{2}t^2 = 0 \right\}$$

$$\text{and } C_2 = \left\{ [x : y : z : t] \in \mathbb{P}^3(\mathbb{C}) \mid x + y + z = y^2 + yz + z^2 + \frac{3 - \sqrt{10}}{2}t^2 = 0 \right\}.$$

Then C_0 , C_1 and C_2 are conics contained in X_{Mu} and belonging to different G_{29} -orbits. Moreover, the G_{29} -orbit of C_0 (resp. C_1 , resp. C_2) has cardinality 480 (resp. 160, resp. 160).

5. THE GROUP $G_{30} = W(H_4)$

Hypothesis. *We assume in this section, and only in this section, that $W = G_{30} = W(H_4)$.*

Recall that G_{30} is the Coxeter group $W(H_4)$ of type H_4 . In other words, we have $G_{30} = \langle s_1, s_2, s_3, s_4 \rangle$ in its natural representation of dimension 4 associated with the Coxeter graph of type H_4 , i.e. given by

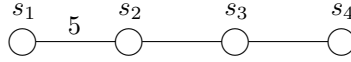

(see [10, Chapter IV] for the definition of a Coxeter graph and [10, Chapter V, §5] for the definition of its associated representation). Explicit matrices may be found in [4]. We refer to [5, Table I] for the numerical informations used here. First, recall that $G'_{30} = G_{30}^{\text{sl}}$ and that $G_{30}/G'_{30} \simeq \mu_2$. As the group is a Coxeter group, there exists a real vector subspace $V_{\mathbb{R}}$ of V such that $V = \mathbb{C} \otimes_{\mathbb{R}} V_{\mathbb{R}}$ and which is stabilized by G_{30} . This also implies that G_{30} admits an invariant f_1 of degree 2, which is the scalar extension of a positive definite quadratic form on $V_{\mathbb{R}}$. We fix a fundamental invariant f_2 of degree 12. If $\lambda \in \mathbb{C}$, we set $f_{2,\lambda} = f_2 + \lambda f_1^6$: this describes (up to scalar) all the fundamental invariants of degree 12. We set

$$X_{\lambda}^{30} = \mathcal{Z}(f_{2,\lambda})/G'_{30}$$

We proved in [5, Theorem 5.4] that X_{λ}^{30} is a K3 surface with ADE singularities (retrieving a result of Barth and the second author [1]). Let $\pi_{\lambda} : \tilde{X}_{\lambda}^{30} \rightarrow X_{\lambda}^{30}$ denote its minimal resolution: it is a smooth K3 surface. As this example was already studied in [1], we will not compute again the singularities of X_{λ}^{30} as well as the transcendental lattices given in Table II. We will just give some complementary informations coming from the general theory of complex reflection group (equations, base locus, ramification) as well as a description of an elliptic fibration together with its singular fibers in most cases.

5.1. Singular dodecics. If $1 \leq k \leq 4$, we denote by W_k the subgroup of G_{30} generated by $\{s_1, s_2, s_3, s_4\} \setminus \{s_k\}$. Then

$$W_1 \simeq \mathfrak{S}_4, \quad W_2 \simeq \langle s_1 \rangle \times \mathfrak{S}_3,$$

$$W_3 \simeq W(I_2(5)) \times \langle s_4 \rangle \quad \text{and} \quad W_4 \simeq W(H_3).$$

Here, $I_2(5)$ (resp. H_3) denotes the complete subgraph of H_4 whose vertices are s_1 and s_2 (resp. s_1, s_2 and s_3) and $W(I_2(5)) = \langle s_1, s_2 \rangle$ (resp. $W(H_3) = \langle s_1, s_2, s_3 \rangle$) is its associated Coxeter group. Note that $W(I_2(5))$ is the dihedral group of order 10. Each maximal parabolic subgroup is conjugate to one of the W_k 's, and only to one of them because they are two by two non-isomorphic. Let $v_k \in V_{\mathbb{R}} \setminus \{0\}$ be such that $V^{W_k} = [v_k]$. We denote by Ω_k the W -orbit of $[v_k]$ in $\mathbb{P}(V)$. Since $-\text{Id}_V \in W$ by [5, Table I] and $N_{G_{30}}(W_k)/W_k$ acts faithfully on $V_{\mathbb{R}}^{W_k} = \mathbb{R}v_k$ (which is of dimension 1), it follows that

$$N_{G_{30}}(W_k) = W_k \times \langle -\text{Id}_V \rangle.$$

Since $N_W(W_k) = W_{[v_k]}$ by [5, Remark 2.5], we get

$$(5.1) \quad |\Omega_k| = \begin{cases} 300 & \text{if } k = 1, \\ 600 & \text{if } k = 2, \\ 360 & \text{if } k = 3, \\ 60 & \text{if } k = 4. \end{cases}$$

Now, $f_1(v_k) \neq 0$ because f_1 is positive definite and $v_k \in V_{\mathbb{R}}$, and we can define $\lambda_k = -f_2(v_k)/f_1(v_k)^6$. Therefore, [5, Corollary 2.4] shows that

$$(5.2) \quad \textit{The singular locus of the surface } \mathcal{Z}(f_{2,\lambda_k}) \textit{ contains } \Omega_k.$$

An explicit computation shows that $\lambda_k \neq \lambda_l$ if $k \neq l$. So this example explains by general theory and simple counting arguments the construction of the four singular dodecics constructed by the second author [21]. It also explains why the singular points are real. However, it does not explain why there is no more singular point, why they are all nodes, or why there is no more value of λ such that $\mathcal{Z}(f_{2,\lambda})$ is singular. All these later facts were explained in [21].

As a consequence of the above discussion, we get:

Lemma 5.3. *If $v \in V \setminus \{0\}$ is such that $[v]$ is a singular point of $\mathcal{Z}(f_{2,\lambda})$ for some $\lambda \in \mathbb{C}$, then W_v is a maximal parabolic subgroup of W (in particular, $W_v \neq 1$).*

5.2. Equations. It follows from [5, Proposition 3.11] that

$$X_{\lambda}^{30} = \{[x_1 : x_3 : x_4 : j] \in \mathbb{P}(2, 20, 30, 60) \mid j^2 = P_{\mathbf{f}}(x_1, -\lambda x_1^6, x_3, x_4)\}.$$

But $\mathbb{P}(2, 20, 30, 60) = \mathbb{P}(1, 10, 15, 30) = \mathbb{P}(1, 2, 3, 6)$. Through this sequence of isomorphisms, there exists a polynomial r_{λ} in variables y_1, y_3, y_4 which is homogeneous of degree 12 if we assign to y_1, y_3, y_4 the weights 1, 2, 3 respectively, and such that $P_{\mathbf{f}}(x_1, -\lambda x_1^6, x_3, x_4) = r_{\lambda}(x_1^5, x_3, x_4)$. Therefore,

$$(5.4) \quad X_{\lambda}^{30} = \{[y_1 : y_3 : y_4 : j] \in \mathbb{P}(1, 2, 3, 6) \mid j^2 = r_{\lambda}(y_1, y_3, y_4)\}.$$

We denote by σ the unique non-trivial element of $G_{30}/G'_{30} \simeq \mu_2$: through the model of X_{λ}^{30} given by (5.4), the action of σ is described by

$$\sigma([y_1 : y_3 : y_4 : j]) = [y_1 : y_3 : y_4 : -j].$$

Note moreover that

$$(5.5) \quad \mathcal{Z}(f_{2,\lambda})/G_{30} = X_{\lambda}^{30}/\mu_2 \simeq \mathbb{P}(2, 20, 30) \simeq \mathbb{P}(1, 2, 3)$$

(see [5, Proposition 3.3]). The branch locus R_{λ} of the quotient morphism $\xi_{\lambda} : X_{\lambda}^{30} \rightarrow \mathbb{P}(1, 2, 3)$ is the zero set of r_{λ} .

5.3. Base locus. Let B denote the *base locus* of the family of dodecic surfaces $(\mathcal{Z}(f_{2,\lambda}))_{\lambda \in \mathbb{C}}$, that is, the subvariety of $\mathbb{P}(V)$ which is contained in all the members of this family. Namely,

$$B = \{p \in \mathbb{P}(V) \mid f_1(p) = f_2(p) = 0\}.$$

Note that $\delta(10) = \delta^*(10) = 2$, so that $\dim V(10) = 2$. We denote by L_{10} the line $\mathbb{P}(V(10))$ in $\mathbb{P}(V)$. The next result was already obtained by Barth and the second author [1], but we give a proof that makes it an application of Lehrer-Springer theory.

Proposition 5.6. *The stabilizer $W(10)$ of L_{10} in W is equal to $C_W(w_{10})$ and has order 600. Moreover,*

$$B = \bigcup_{x \in W} x(L_{10})$$

consists of 24 lines, which split into two G'_{30} -orbits of cardinality 12.

Proof. This is mainly a consequence of [5, Theorem 3.13]. Indeed, the fact that

$$B = \bigcup_{x \in W} x(L_{10})$$

follows from [5, Theorem 3.13(d)]. Moreover, by [5, Theorem 3.13(f)], we have that $W(10) = C_W(w_{10})$ is a reflection group for its action on $V(10)$, and admits $(20, 30)$ as list of degrees. So $|W(10)| = 20 \cdot 30 = 600$ by [5, (3.1)].

The only fact that is not covered by [5, Theorem 3.13] is that the 24 lines forming B split into two G'_{30} -orbits of cardinality 12: but this follows from the fact that $W(10) \subset G'_{30}$ (which can be checked for instance with MAGMA). \square

Let B' denote the image of B in $\mathbb{P}(V)/W'$. Then it follows from Proposition 5.6 that B' is the union of two irreducible components B^+ and B^- . We denote by \tilde{B}^+ and \tilde{B}^- their respective strict transforms in \tilde{X}_λ^{31} .

Let us examine some particular points of B . First, note that B does not contain a singular point of $\mathcal{Z}(f_{2,\lambda})$ since we have seen in §5.1 that $f_1(v) \neq 0$ for any $v \in V \setminus \{0\}$ such that $[v]$ is a singular point of $\mathcal{Z}(f_{2,\lambda})$.

Now, let $k \in \{20, 30\}$. Examining Table I, we see that $\delta(k) = \delta^*(k) = 1$. By Springer Theory [5, Theorem 3.13], this implies that $\dim V(k) = 1$, that $W(V(k)) = 1$ and that $W(k) = \langle w_k \rangle$. Let z_k denote the image of $V(k)$ in $\mathbb{P}(V)$. Then the stabilizer of z_k in W is $W(k)$ and since $\det w_k = \zeta_k^{-60} = 1$ (see [5, Theorem 3.13(f)]), this implies that the W -orbit Ω_k of z_k has cardinality $14400/k$ and splits into two W' -orbits. We denote by $a_{(k/10)-1}$ the image of z_k in $\mathcal{Z}(f_{2,\lambda})/W \simeq \mathbb{P}(1, 2, 3)$: it follows from [5, Theorem 3.13(d)] that

$$a_1 = [0 : 1 : 0] \quad \text{and} \quad a_2 = [0 : 0 : 1].$$

Note that a_r is an A_r singularity of $\mathbb{P}(1, 2, 3)$. Now, the morphism $X_\lambda^{30} \rightarrow \mathbb{P}(1, 2, 3)$ is unramified above a_r because $W(20)$ and $W(30)$ are contained in W' . So let a_r^\pm denote the two points of X_λ^{30} above a_r : in the model given in §5.2, we have

$$a_1^\pm = [0 : 1 : 0 : \pm j_1] \quad \text{and} \quad a_2^\pm = [0 : 0 : 1 : \pm j_2]$$

for some $j_r \in \mathbb{C}^\times$. They are both A_r singularities of X_λ^{30} (note that this is true for any value of λ). We choose the value of j_r so that $a_r^+ \in B^+$ (and then $a_r^- \in B^-$). Recall from [1] that

$$(5.7) \quad (X_\lambda^{30})_{\text{sing}} \cap B' = \{a_1^+, a_1^-, a_2^+, a_2^-\}.$$

Again, this fact holds for any value of λ .

Lemma 5.8. *Let $x \in X_\lambda^{30} \setminus \{a_1^\pm, a_2^\pm\}$. Then x is singular if and only if $\xi_\lambda(x)$ is a singular point of the branch locus R_λ . In this case, the singularity x is of the same type as the singularity $\xi_\lambda(x)$ of the curve R_λ .*

Proof. Since the only singular points of $\mathbb{P}(1, 2, 3)$ are a_1 and a_2 , the result follows from [5, Proposition 4.4]. \square

5.4. Elliptic fibration. With the model of X_λ^{30} given in §5.2, we can define a map

$$\begin{aligned} \varphi_\lambda : X_\lambda^{30} \setminus \{a_2^+, a_2^-\} &\longrightarrow \mathbb{P}^1(\mathbb{C}) \\ [y_1 : y_3 : y_4 : j] &\longmapsto [y_1^2 : y_3]. \end{aligned}$$

Since this map factorizes through the quotient $\mathbb{P}(1, 2, 3)$ of X_λ^{30} , the same argument as in the proof of Proposition 4.7 shows that:

Proposition 5.9. *The map $\varphi_\lambda \circ \pi_\lambda : \tilde{X}_\lambda^{30} \setminus (\pi_\lambda^{-1}(a_2^+) \cup \pi_\lambda^{-1}(a_2^-)) \longrightarrow \mathbb{P}^1(\mathbb{C})$ extends to a morphism of algebraic varieties*

$$\tilde{\varphi}_\lambda : \tilde{X}_\lambda^{30} \longrightarrow \mathbb{P}^1(\mathbb{C}).$$

Remark 5.10. By the same argument as in Remark 4.8, the elliptic fibration $\tilde{\varphi}_\lambda : \tilde{X}_\lambda^{30} \longrightarrow \mathbb{P}^1(\mathbb{C})$ admits two sections $\tilde{\theta}_\lambda^\pm : \mathbb{P}^1(\mathbb{C}) \longrightarrow \tilde{X}_\lambda^{30}$ which satisfy $\tilde{\theta}^- = \sigma \circ \tilde{\theta}^+$. \blacksquare

Note that the above result is independent of λ . However, we will see in the next corollary that the singular fibers of the elliptic fibration $\tilde{\varphi}_\lambda$ depend on λ . We will not determine the fiber in all cases, but only whenever the following hypothesis is satisfied:

Hypothesis (H $_\lambda$). *If x and y are two different singular points of $X_\lambda^{30} \setminus \{a_1^\pm, a_2^\pm\}$, then $\varphi_\lambda(x) \neq \varphi_\lambda(y)$.*

Note that Hypothesis (H $_\lambda$) holds for all but a finite number of values of λ . Moreover, an explicit computation with MAGMA shows that it holds for $\lambda \in \{\lambda_1, \lambda_2, \lambda_3, \lambda_4\}$.

Corollary 5.11. *Let $\lambda \in \mathbb{C}$ be such that (H $_\lambda$) holds. Then the singular fibers of the elliptic fibration $\tilde{\varphi}_\lambda : \tilde{X}_\lambda^{30} \rightarrow \mathbb{P}^1(\mathbb{C})$ are given by Table III.*

Proof. Let us first examine the fiber at $[0 : 1]$. For this particular fiber, the description will not depend on λ . Note that

$$\overline{\varphi_\lambda^{-1}([0 : 1])} = B' = B^+ \cup B^-.$$

We now apply results from Appendix A in the case where $(k, l) = (1, 2)$. Let Δ_1 and Δ_2 denote the lines in $\hat{\mathbb{P}}(1, 2, 3)$ described in the Appendix A and let $\hat{\varphi}_{1,2} : \hat{\mathbb{P}}(1, 2, 3) \rightarrow \mathbb{P}^1(\mathbb{C})$ denote the map constructed in (A.1). It follows from Proposition A.3 that

$$(\clubsuit) \quad \hat{\varphi}_{1,2}^{-1}([0 : 1]) = \Delta_2 \cup \tilde{\Delta}^{(1)},$$

where $\Delta^{(1)} = \{[y_1 : y_3 : y_4] \in \mathbb{P}(1, 2, 3) \mid y_1 = 0\}$ and $\tilde{\Delta}^{(1)}$ is the strict transform of $\Delta^{(1)}$ in $\hat{\mathbb{P}}(1, 2, 3)$. By the argument in Remark 4.8, the two smooth rational curves $\Delta_1^{a_2^\pm}$ and $\Delta_2^{a_2^\pm}$ above the point a_2^\pm can be numbered so that $\Delta_k^{a_2^\pm}$ is mapped isomorphically to Δ_k through the quotient morphism $\tilde{X}_\lambda^{30} \rightarrow \mathbb{P}(1, 2, 3)$, moreover, the inverse image of $\Delta^{(1)}$ in X_λ is $B^+ \cup B^-$. So, if we denote by $\Delta^{a_1^\pm}$ the smooth rational curve above the points a_1^\pm and by \tilde{B} (resp. \tilde{B}^\pm) the strict transform of B' (resp. B^\pm) in \tilde{X}_λ^{30} , then it follows from (\clubsuit) and the construction of $\tilde{\varphi}_\lambda$ that

$$\tilde{\varphi}_\lambda^{-1}([0 : 1]) = \Delta^{a_1^+} \cup \Delta^{a_1^-} \cup \Delta_2^{a_2^+} \cup \Delta_2^{a_2^-} \cup \tilde{B}^+ \cup \tilde{B}^-.$$

Since $\tilde{B}^+ \cap \tilde{B}^- \neq \emptyset$, since $\Delta^{a_1^\varepsilon} \cap B^\eta \neq \emptyset$ if and only if $\varepsilon = \eta$, since $\Delta_2^{a_2^\varepsilon} \cap B^\eta \neq \emptyset$ if and only if $\varepsilon = \eta$ and since $\Delta^{a_1^\varepsilon} \cap \Delta_2^{a_2^\eta} = \emptyset$, the Kodaira-Néron classification of singular fibers implies that

$$(\diamond) \quad \tilde{\varphi}_\lambda^{-1}([0 : 1]) \text{ is of type } \tilde{D}_5.$$

Note that (\diamond) holds for any value of λ . We will now start the discussion according to the value of λ .

Assume that $\lambda \notin \{\lambda_1, \lambda_2, \lambda_3, \lambda_4\}$. Then $X_\lambda^{30} \setminus \{a_1^\pm, a_2^\pm\}$ has 6 singular points x_1, \dots, x_6 , of respective type A_1, A_1, A_1, A_2, A_2 and A_4 . Let x be one of these 6 points and let m denote its Milnor number. Then $\pi_\lambda^{-1}(x)$ is the union of m smooth rational curves $\Delta_1^x, \dots, \Delta_m^x$. Let E^x denote the closure of $\varphi_\lambda^{-1}(\varphi_\lambda(x))$ and let \tilde{E}^x denote its strict transform in \tilde{X}_λ^{30} . Then

$$(\heartsuit) \quad \tilde{\varphi}_\lambda^{-1}(\varphi_\lambda(x)) = \tilde{E}^x \cup \Delta_1^x \cup \dots \cup \Delta_m^x.$$

So $\tilde{\varphi}_\lambda^{-1}(\varphi_\lambda(x))$ is a singular fiber. Let us determine its type.

Note that $\hat{\varphi}_{1,2}^{-1}(\varphi_\lambda(x))$ is a projective line by Proposition A.3 and Remark A.5. Therefore, its double cover \tilde{E}^x has at most two irreducible components. Note also that the multiplicity of Δ_k^m in the singular fiber $\tilde{\varphi}_\lambda^{-1}(\varphi_\lambda(x))$ is equal to one. Therefore, according to the Kodaira-Néron classification of singular fibers, (\heartsuit) gives the following possibilities:

- If $x = x_1, x_2$ or x_3 is an A_1 singularity, then $\tilde{\varphi}_\lambda^{-1}(\varphi_\lambda(x))$ is of type \tilde{A}_1 or $\tilde{A}_1^\#$ if \tilde{E}^x is irreducible or of type \tilde{A}_2 or $\tilde{A}_2^\#$ if \tilde{E}^x has two irreducible components.
- If $x = x_4$ or x_5 is of type A_2 , then $\tilde{\varphi}_\lambda^{-1}(\varphi_\lambda(x))$ is of type \tilde{A}_2 or $\tilde{A}_2^\#$ if \tilde{E}^x is irreducible or of type \tilde{A}_3 if \tilde{E}^x has two irreducible components.
- If $x = x_6$ is of type A_4 , then $\tilde{\varphi}_\lambda^{-1}(\varphi_\lambda(x))$ is of type \tilde{A}_4 if \tilde{E}^x is irreducible or of type \tilde{A}_5 if \tilde{E}^x has two irreducible components.

| $\mathcal{L}_{\text{sing}}(f_{2,\lambda})$ | singularities of X_λ^{30} | $\mathbf{T}_{\tilde{X}_\lambda^{30}}$ | singular fibers of $\tilde{\varphi}_\lambda$ | $\text{MW}_{\tilde{\theta}_\lambda^+}(\tilde{\varphi}_\lambda)$ |
|--|-----------------------------------|---------------------------------------|---|---|
| \emptyset | $A_4 + 4A_2 + 5A_1$ | Theorem 1.2 | $\tilde{D}_5 + \tilde{A}_4 + 2\tilde{A}_2 + 3\tilde{A}_1^{(\dagger)}$ | \mathbb{Z} |
| $60A_1$ | $E_8 + 3A_2 + 4A_1$ | $(4 \ 2 \ 34)$ | $\tilde{E}_8 + \tilde{D}_5 + \tilde{A}_2 + 2\tilde{A}_1$ | \mathbb{Z} |
| $300A_1$ | $E_6 + A_4 + 2A_2 + 4A_1$ | $(12 \ 6 \ 58)$ | $\tilde{E}_6 + \tilde{D}_5 + \tilde{A}_4 + 2\tilde{A}_1$ | \mathbb{Z} |
| $360A_1$ | $D_7 + 4A_2 + 3A_1$ | $(6 \ 0 \ 132)$ | $\tilde{D}_7 + \tilde{D}_5 + 2\tilde{A}_2 + \tilde{A}_1$ | \mathbb{Z} |
| $600A_1$ | $D_5 + A_4 + 3A_2 + 3A_1$ | $(6 \ 0 \ 220)$ | $2\tilde{D}_5 + \tilde{A}_4 + \tilde{A}_2 + \tilde{A}_1$ | \mathbb{Z} |

TABLE III. Some numerical data for the family of K3 surfaces $(\tilde{X}_\lambda^{30})_{\lambda \in \mathbb{C}}$
 (†) Only for λ generic

Let χ_k denote the Euler characteristic of the singular fiber above x_k . Since the Euler characteristic of $\tilde{\varphi}_\lambda^{-1}([0 : 1])$ is equal to 7 by (\diamond) , we have

$$(\spadesuit) \quad \chi_1 + \chi_2 + \chi_3 + \chi_4 + \chi_5 + \chi_6 \leq 24 - 7 = 17.$$

But it follows from the above discussion that

$$\chi_1 \geq 2, \quad \chi_2 \geq 2, \quad \chi_3 \geq 2, \quad \chi_4 \geq 3, \quad \chi_5 \geq 3 \quad \text{and} \quad \chi_6 \geq 5.$$

Therefore, (\spadesuit) forces $\chi_1 = \chi_2 = \chi_3 = 2$, $\chi_4 = \chi_5 = 3$ and $\chi_6 = 5$. And so the singular fibers are of the types described in the first line of Table III.

The cases mentioned in the last four lines of Table III follow from a similar discussion, the conclusion using the same argument based on the Euler characteristic. \square

6. THE GROUP G_{31}

Hypothesis. *We assume in this section, and only in this section, that $W = G_{31}$.*

Let

$$s_1 = \begin{pmatrix} 0 & 1 & 0 & 0 \\ 1 & 0 & 0 & 0 \\ 0 & 0 & 1 & 0 \\ 0 & 0 & 0 & 1 \end{pmatrix}, \quad s_2 = \begin{pmatrix} 1 & 0 & 0 & 0 \\ 0 & 0 & 1 & 0 \\ 0 & 1 & 0 & 0 \\ 0 & 0 & 0 & 1 \end{pmatrix},$$

$$s_3 = \begin{pmatrix} 1 & 0 & 0 & 0 \\ 0 & 1 & 0 & 0 \\ 0 & 0 & -1 & 0 \\ 0 & 0 & 0 & 1 \end{pmatrix} \quad \text{and} \quad s_4 = \frac{1}{2} \begin{pmatrix} 1 & -1 & -1 & -1 \\ -1 & 1 & -1 & -1 \\ -1 & -1 & 1 & -1 \\ -1 & -1 & -1 & 1 \end{pmatrix}.$$

Then $W(F_4) = G_{28} = \langle s_1, s_2, s_3, s_4 \rangle$. We set

$$s_5 = \begin{pmatrix} 0 & i & 0 & 0 \\ -i & 0 & 0 & 0 \\ 0 & 0 & 1 & 0 \\ 0 & 0 & 0 & 1 \end{pmatrix}.$$

Then $G_{31} = \langle s_1, s_2, s_3, s_4, s_5 \rangle$. Note that, even though G_{31} is of rank 4, it cannot be generated by only 4 reflections. Note also that $|G_{31}/G'_{31}| = 2$ and that $G'_{31} = G_{31}^{\text{SL}}$.

Recall from [5, Table I] that $\text{Deg}(W) = (8, 12, 20, 24) = (d_1, d_2, d_3, d_4)$ and we denote by $\mathbf{f} = (f_1, f_2, f_3, f_4)$ a family of fundamental invariants such that $\deg(f_i) = d_i$. Then f_1 and f_2 are uniquely determined (up to a scalar). We have

$$f_1 = \Sigma(x^8) + 14\Sigma(x^4y^4) + 168x^2y^2z^2t^2$$

$$f_2 = \Sigma(x^{12}) - 33\Sigma(x^8y^4) + 792\Sigma(x^6y^2z^2t^2) + 330\Sigma(x^4y^4z^4).$$

We will make a special choice for f_3 as follows. First, let N denote the normalizer of G_{28} in G_{31} . Then N has index 10 in G_{31} and we denote by $[G_{31}/N]$ a set of representatives of the cosets in G_{31}/N . Then $x^2 + y^2 + z^2 + t^2$ is G_{28} -invariant (but not N -invariant) and it turns out that

$$f_3 = \prod_{g \in [G_{31}/N]} g(x^2 + y^2 + z^2 + t^2)$$

is a fundamental invariant of degree 20 of G_{31} . Of course, $\mathcal{Z}(f_3)$ is not irreducible (it is the union of 10 quadrics). We choose the set of representatives $[G_{31}/N]$ such that the coefficient of $x^{14}y^2z^2t^2$ in f_3 is equal to 648. Then

$$\begin{aligned} f_3 = & 648(\Sigma(x^{14}y^2z^2t^2) - \Sigma(x^{12}y^4z^4) - \Sigma(x^{10}y^6z^2t^2) \\ & + 2\Sigma(x^8y^8z^4) + 13\Sigma(x^8y^4z^4t^4) - 14\Sigma(x^6y^6z^6t^2)). \end{aligned}$$

Finally, we set

$$\begin{aligned} f_4 = & 3888(\Sigma(x^{18}y^2z^2t^2) + 2\Sigma(x^{16}y^4z^4) - 12\Sigma(x^{14}y^6z^2t^2) - 2\Sigma(x^{12}y^8z^4) \\ & + 76\Sigma(x^{12}y^4z^4t^4) + 22\Sigma(x^{10}y^{10}z^2t^2) - 52\Sigma(x^{10}y^6z^6t^2) \\ & + 36\Sigma(x^8y^8z^8) + 36\Sigma(x^8y^8z^4t^4) - 8x^6y^6z^6t^6). \end{aligned}$$

Then $\mathbf{f} = (f_1, f_2, f_3, f_4)$ is a family of fundamental invariants of G_{31} . Note that the coefficients 648 (for f_3) and 3888 (for f_4) are just for simplifying the general equation of the surfaces studied in this section.

If $\lambda \in \mathbb{C}$, we set $f_{3,\lambda} = f_3 + \lambda f_1 f_2$. Recall from [3] that there are only 6 values of λ such that $\mathcal{Z}(f_{3,\lambda})$ is singular: one of them is 0, which is the only value of λ for which $\mathcal{Z}(f_{3,\lambda})$ is not irreducible. We set

$$X_\lambda^{31} = \mathcal{Z}(f_{3,\lambda})/G'_{31}$$

(it is a K3 surface with ADE singularities by [5, Theorem 5.4]) and we denote by \tilde{X}_λ^{31} its minimal resolution (it is a smooth K3 surface). We aim in this section to prove the results stated in Table II, namely compute the singularities of X_λ^{31} , the Picard number and the transcendental lattice of \tilde{X}_λ^{31} . We will also provide some more informations about the geometry of $\mathcal{Z}(f_{3,\lambda})$ and X_λ^{31} (lines, branch locus of the double cover $X_\lambda^{31} \rightarrow \mathcal{Z}(f_{3,\lambda})/G_{31} = \mathbb{P}^2(\mathbb{C}), \dots$).

6.1. Equations, branch locus. Let $\xi_\lambda : X_\lambda^{31} \rightarrow \mathcal{Z}(f_{3,\lambda})/G_{31} = \mathbb{P}^2(\mathbb{C})$ be the natural map. This is a double cover, whose branch locus $R_\lambda \subset \mathbb{P}^2(\mathbb{C})$ is a sextic that will be described below. First [5, Proposition 3.11].

$$X_\lambda^{31} = \{[x_1 : x_2 : x_4 : j] \in \mathbb{P}(8, 12, 24, 60) \mid j^2 = P_{\mathbf{f}}(x_1, x_2, -\lambda x_1 x_2, x_4)\}.$$

But $\mathbb{P}(8, 12, 24, 60) \simeq \mathbb{P}(2, 3, 6, 15) \simeq \mathbb{P}(2, 1, 2, 5)$. So there exists a polynomial $q_\lambda \in \mathbb{C}[y_1, y_2, y_4]$ which is homogeneous of degree 10 if we assign to y_1, y_2, y_4 the degrees 2, 1, 2 respectively, and such that

$$X_\lambda^{31} = \{[y_1 : y_2 : y_4 : j] \in \mathbb{P}(2, 1, 2, 5) \mid j^2 = q_\lambda(y_1, y_2, y_4)\}.$$

But $\mathbb{P}(2, 1, 2) \simeq \mathbb{P}(1, 1, 1) = \mathbb{P}^2(\mathbb{C})$, so there exists a polynomial $r_\lambda(z_1, z_2, z_4) \in \mathbb{C}[z_1, z_2, z_4]$, which is homogeneous of degree 5 if we assign to z_1, z_2, z_4 the degrees 1, 1, 1 respectively, and such that

$$(6.1) \quad X_\lambda^{31} = \{[y_1 : y_2 : y_4 : j] \in \mathbb{P}(2, 1, 2, 5) \mid j^2 = r_\lambda(y_1, y_2^2, y_4)\}.$$

Through this description, the action of the unique non-trivial element σ of G_{31}/G'_{31} is given by

$$\sigma([y_1 : y_2 : y_4 : j]) = [y_1 : y_2 : y_4 : -j] = [y_1 : -y_2 : y_4 : j],$$

and the morphism $X_\lambda^{31} \rightarrow \mathbb{P}^2(\mathbb{C})$ is given explicitly by

$$[y_1 : y_2 : y_4 : j] \mapsto [y_1 : y_2^2 : y_4].$$

So the branch locus of ξ_λ is

$$(6.2) \quad R_\lambda = \{[z_1 : z_2 : z_4] \in \mathbb{P}^3(\mathbb{C}) \mid z_2 r_\lambda(z_1, z_2, z_4) = 0\}.$$

In other words, the sextic R_λ is the union of the projective line \bar{B}_2 defined by $z_2 = 0$ and of the quintic $R'_\lambda = \mathcal{Z}(r_\lambda)$.

6.1.1. *Other model.* Let

$$\mathcal{X}_\lambda = \{[z_1 : z_2 : z_4 : t] \in \mathbb{P}(1, 1, 1, 3) \mid t^2 = z_2 r_\lambda(z_1, z_2, z_4)\}.$$

Then $\mathcal{X}_\lambda \rightarrow \mathbb{P}^2(\mathbb{C})$, $[z_1 : z_2 : z_4 : t] \mapsto [z_1 : z_2 : z_4]$ is a double cover of $\mathbb{P}^2(\mathbb{C})$ ramified on the sextic $R_\lambda = \bar{B}_2 \cup R'_\lambda$. The rational map

$$\begin{aligned} \iota : \quad \mathbb{P}(2, 1, 2, 5) &\longrightarrow \mathbb{P}(1, 1, 1, 3) \\ [y_1 : y_2 : y_4 : j]_{2,1,2,5} &\longmapsto [y_1 : y_2^2 : y_4 : y_2 j]_{1,1,1,3} \end{aligned}$$

is well-defined outside of $[0 : 0 : 0 : 1]_{2,1,2,5}$ and is birational (it is for instance an isomorphism between the open subsets defined respectively by $y_2 \neq 0$ and $z_2 \neq 0$). But note that $[0 : 0 : 0 : 1]_{2,1,2,5} \notin X_\lambda^{31}$ and that $\iota(X_\lambda^{31}) = \mathcal{X}_\lambda^{31}$. Also X_λ^{31} (resp. \mathcal{X}_λ) is contained in the open subsets defined by $(y_i \neq 0)_{i \in \{1,2,4\}}$ (resp. $(z_i \neq 0)_{i \in \{1,2,4\}}$). An immediate computation in all these open subsets show that ι induces an isomorphism $X_\lambda^{31} \xrightarrow{\sim} \mathcal{X}_\lambda$. As this second model is somewhat simpler to work with, we will now identify X_λ^{31} with \mathcal{X}_λ and so view X_λ^{31} in the more classical model for double covers of $\mathbb{P}^2(\mathbb{C})$ ramified above a sextic:

$$(6.3) \quad X_\lambda^{31} = \{[z_1 : z_2 : z_4 : t] \in \mathbb{P}(1, 1, 1, 3) \mid t^2 = z_2 r_\lambda(z_1, z_2, z_4)\}.$$

Through this model, the double cover morphism $\xi_\lambda : X_\lambda^{31} \rightarrow \mathbb{P}^2(\mathbb{C})$ is just given by $\xi_\lambda([z_1 : z_2 : z_4 : t]) = [z_1 : z_2 : z_4]$.

6.1.2. *Value of r_λ .* The explicit value of the polynomial r_λ is given below (recall that it depends on our special choice of the family \mathbf{f} of fundamental invariants and a suitable normalization for J):

$$\begin{aligned} r_\lambda = & -432 \lambda^3 (\lambda + 1) z_1^3 z_2^2 - 108 \lambda^2 z_1^3 z_2 z_4 \\ & + (12500 \lambda^6 + 22500 \lambda^5 + 10800 \lambda^4 + 864 \lambda^3) z_1^2 z_2^3 \\ & + (4125 \lambda^4 + 3420 \lambda^3 + 216 \lambda^2) z_1^2 z_2^2 z_4 + 222 \lambda^2 z_1^2 z_2 z_4^2 + z_1^2 z_4^3 \\ & - 432 \lambda^3 z_1 z_2^4 + (900 \lambda^3 - 108 \lambda^2) z_1 z_2^3 z_4 + (-500 \lambda^3 + 210 \lambda^2) z_1 z_2^2 z_4^2 \\ & + (-150 \lambda^2 - 24 \lambda - 2) z_1 z_2 z_4^3 - 2 z_1 z_4^4 + z_2^2 z_4^3 - 2 z_2 z_4^4 + z_4^5. \end{aligned}$$

Remark 6.4. Assume in this remark, and only in this remark, that $\lambda = 0$. Then $X_0^{31} = \{[z_1 : z_2 : z_4 : t] \in \mathbb{P}(1, 1, 1, 3) \mid t^2 = z_4^3(z_1^2 + z_2^2 + z_4^2 - 2z_1z_2 - 2z_1z_4 - 2z_2z_4)\}$. The singular locus is a union of the point $[1 : 0 : 1 : 0]$ and the smooth rational curve defined by $z_4 = t = 0$. So the singular locus has dimension 1 and the surface X_0^{31} will not be considered in this section. ■

Hypothesis. *From now on, and until the end of this section, we assume that $\lambda \neq 0$.*

6.2. **Singular icosics.** As explained in the introduction of this section, it follows from [3] that there are 5 values of $\lambda \in \mathbb{C}^\times$ such that $\mathcal{Z}(f_{3,\lambda})$ is singular. We explain here what are these special values, and how we can recover the singularities of $\mathcal{Z}(f_{3,\lambda})/G'_{31}$ thanks to [5, Proposition 4.4] and MAGMA computations.

First, we set

$$W_{145} = \langle s_1, s_4, s_5 \rangle, \quad W_{245} = \langle s_2, s_4, s_5 \rangle \quad \text{and} \quad W_{1234} = \langle s_1, s_2, s_3, s_4 \rangle.$$

Note that these are representatives of conjugacy classes of maximal parabolic subgroups of W . If $k \in \{145, 245, 1234\}$, we denote by v_k a generator of the line V^{W_k} , and we set $z_k = [v_k] = V^{W_k} \in \mathbb{P}(V) = \mathbb{P}^3(\mathbb{C})$. We also set $N_k = N_W(W_k)$ and we denote by Ω_k the W -orbit of z_k : it follows from [5, Remark 2.5] that $|\Omega_k| = |W|/|N_k|$. Concretely, we have:

$$(6.5) \quad |\Omega_k| = \begin{cases} 960 & \text{if } k = 145, \\ 480 & \text{if } k = 245. \\ 60 & \text{if } k = 1234. \end{cases}$$

A MAGMA computation shows that

$$(6.6) \quad \mathcal{Z}(f_1) \text{ and } \mathcal{Z}(f_2) \text{ are smooth.}$$

In particular, $v_k \notin \mathcal{Z}(f_1) \cup \mathcal{Z}(f_2)$ by [5, Corollary 2.4]. So we can define $\lambda_k = -f_3(v_k)/(f_1 f_2)(v_k)$. It turns out that $\lambda_{1234} = 0$, so that $f_{3,\lambda_{1234}} = f_3$ is not irreducible: this case does not lead to a K3 surface and will not be studied here.

Therefore, we have found in this way two values of λ , namely λ_{145} and λ_{245} , such that $\mathcal{Z}(f_{3,\lambda})$ is irreducible and singular. But there are three more values of λ such that $\mathcal{Z}(f_{3,\lambda})$ is irreducible and singular [3]: this shows that, by opposition with the cases of G_{29} (in degree 8) and G_{30} (in degree 12), [5, Corollary 2.4] is not sufficient to

explain all the singular icosics that can be constructed from fundamental invariants of G_{31} of degree 20. With our choice of the family \mathbf{f} of fundamental invariants of G_{31} , we have

$$\lambda_{145} = -\frac{8}{25} \quad \text{and} \quad \lambda_{245} = -\frac{81}{175}.$$

We set

$$\lambda_1 = 1, \quad \lambda_2 = -\frac{1}{3} \quad \text{and} \quad \lambda_3 = -\frac{1}{2}.$$

Then λ_{145} , λ_{245} , λ_1 , λ_2 , λ_3 are the five values of λ such that $\mathcal{L}(f_{3,\lambda})$ is irreducible and singular. By [3, Proposition 3.6 and Table 4] and the correction statement at <https://doi.org/10.1080/10586458.2018.1555778>, the singularities of $\mathcal{L}(f_{3,\lambda_k})$ are given by

$$(6.7) \quad \mathcal{L}_{\text{sing}}(f_{3,\lambda_k}) = \begin{cases} 960 A_1 & \text{if } k = 145, \\ 480 A_1 & \text{if } k = 245, \\ 1920 A_1 & \text{if } k = 1, \\ 1440 A_2 & \text{if } k = 2, \\ 640 A_3 & \text{if } k = 3. \end{cases}$$

6.3. Springer theorem, base locus. Recall from [5, Table I] that

$$\begin{cases} \text{Deg}(W) = (8, 12, 20, 24), \\ \text{Codeg}(W) = (0, 12, 16, 28). \end{cases}$$

The following facts can be deduced immediately from this and from [5, Theorem 3.13]:

- (a) $\delta(8) = \delta^*(8) = 2$, so $\dim V(8) = 2$. We denote by L_8 the line $\mathbb{P}(V(8)) \subset \mathbb{P}(V) = \mathbb{P}^3(\mathbb{C})$. Then $W(8) = C_W(w_8)$ is a reflection group for its action on $V(8)$, and its degrees are $(8, 24)$. So $|W(8)| = 8 \cdot 24 = 192$ by [5, (3.1)], and so the W -orbit of L_8 contains 240 lines.
- (b) $\delta(12) = \delta^*(12) = 2$, so $\dim V(12) = 2$. We denote by L_{12} the line $\mathbb{P}(V(12)) \subset \mathbb{P}(V) = \mathbb{P}^3(\mathbb{C})$. Then $W(12) = C_W(w_{12})$ is a reflection group for its action on $V(12)$, and its degrees are $(12, 24)$. So $|W(12)| = 12 \cdot 24 = 288$ by [5, (3.1)], and so the W -orbit of L_{12} contains 160 lines.
- (c) $\delta(20) = \delta^*(20) = 1$, so $\dim V(20) = 1$. We denote by $z_{20} \in \mathbb{P}^3(\mathbb{C})$ the point defined by the line $V(20)$. Then $W(20) = C_W(w_{20}) = \langle w_{20} \rangle$ is cyclic of order 20.
- (d) $\delta(24) = \delta^*(24) = 1$, so $\dim V(24) = 1$. We denote by $z_{24} \in \mathbb{P}^3(\mathbb{C})$ the point defined by the line $V(24)$. Then $W(24) = C_W(w_{24}) = \langle w_{24} \rangle$ is cyclic of order 24.

It follows from the above discussion and [5, Theorem 3.13(f)] that, if $e \in \{8, 12, 20, 24\}$, then the eigenvalues of w_e are ζ_e^{-7} , ζ_e^{-11} , ζ_e^{-19} and ζ_e^{-23} and so

$$(6.8) \quad \det(w_e) = \zeta_e^{-60} = \begin{cases} -1 & \text{if } e \in \{8, 24\}, \\ 1 & \text{if } e \in \{12, 20\}. \end{cases}$$

Proposition 6.9. *With the above notation, we have that $z_{24} \in \mathcal{L}(f_{3,\lambda})$, that L_8 and L_{12} are contained in $\mathcal{L}(f_{3,\lambda})$ and that $z_{20} \notin \mathcal{L}(f_{3,\lambda})$.*

Proof. The facts that $z_{24} \in \mathcal{L}(f_{3,\lambda})$ and that L_8 and L_{12} are contained in $\mathcal{L}(f_{3,\lambda})$ follow from [5, Lemma 2.2].

Again by [5, Lemma 2.2], we have $f_1(z_{20}) = f_2(z_{20}) = f_4(z_{20}) = 0$, so that we cannot have $f_3(z_{20}) = 0$ since 0 is the only common zeros of the fundamental invariants $(f_k)_{1 \leq k \leq 4}$. Hence $z_{20} \notin \mathcal{L}(f_{3,\lambda})$. \square

This shows in particular that $\mathcal{L}(f_{3,\lambda})$ contains at least 400 lines (the W -orbit of L_8 of length 240 and the W -orbit of L_{12} of length 160): it can be shown that, for λ generic, these are the only lines contained in $\mathcal{L}(f_{3,\lambda})$.

Now, let

$$B = \mathcal{L}(f_3) \cap \mathcal{L}(f_1 f_2)$$

denote the *base locus* of the family $(\mathcal{L}(f_{3,\lambda}))_{\lambda \in \mathbb{C}^\times}$. We write

$$B_1 = \mathcal{L}(f_3) \cap \mathcal{L}(f_1) \quad \text{and} \quad B_2 = \mathcal{L}(f_3) \cap \mathcal{L}(f_2),$$

so that

$$B = B_1 \cup B_2.$$

By [5, Theorem 3.13(d)], we have

$$(6.10) \quad B_1 = \bigcup_{x \in W} x(L_{12}) \quad \text{and} \quad B_2 = \bigcup_{x \in W} x(L_8).$$

We denote by B' the image of B in $\mathbb{P}(V)/W'$ (it is the base locus of the family $(X_\lambda^{31})_{\lambda \in \mathbb{C}}$). Then

$$B' = B'_1 \cup B'_2,$$

where B'_j denotes the image of B_j . It can be checked that the stabilizers $C_W(w_8)$ and $C_W(w_{12})$ of L_8 and L_{12} in W respectively are not contained in W' . So B'_1 (resp. B'_2) is also the image of L_{12} (resp. L_8), hence it is a (possibly singular) rational curve.

Proposition 6.11. *The rational curve B'_2 is smooth, while the rational curve B'_1 has singularities $A_1 + A_2$.*

Proof. From the explicit formula for r_λ given in §6.1.2, we have

$$B'_1 = \{[z_1 : z_2 : z_4 : t] \in \mathbb{P}(1, 1, 1, 3) \mid z_1 = 0 \text{ and } t^2 = z_2 z_4^3 (z_2 - z_4)^2\}$$

and
$$B'_2 = \{[z_1 : z_2 : z_4 : t] \in \mathbb{P}(1, 1, 1, 3) \mid z_2 = t = 0\}.$$

So $B'_2 = \mathbb{P}(1, 1) = \mathbb{P}^1(\mathbb{C})$ as expected.

Let us now consider the case of B'_1 . An easy computation in the affine charts defined by $z_2 \neq 0$ and $z_4 \neq 0$ gives two singular points $[0 : 1 : 0 : 0]$ and $[0 : 1 : 1 : 0]$ which are singularities of type A_2 and A_1 respectively. \square

Note that the set theoretic intersection of B'_1 and B'_2 consists of only one point (let us call it z'_{24} as it is the image of $z_{24} \in \mathcal{Z}(f_{3,\lambda}) \subset \mathbb{P}(V)$). Its coordinates are given by

$$z'_{24} = [0 : 0 : 1 : 0] \in X_\lambda^{31} \subset \mathbb{P}(1, 1, 1, 3).$$

Its image $\bar{z}_{24} = [0 : 0 : 1] \in \mathbb{P}^2(\mathbb{C})$ is a smooth point of the branch locus R_λ (for all values of λ , because $r_\lambda(0, 0, 1) = 1 \neq 0$).

Remark 6.12. Let \bar{B}_1 and \bar{B}_2 denote the respective images of B'_1 and B'_2 in $X_\lambda^{31}/\langle\sigma\rangle = \mathbb{P}^2(\mathbb{C})$. Then \bar{B}_1 (resp. \bar{B}_2) is the line defined by the equation $z_1 = 0$ (resp. $z_2 = 0$). Note that the morphism $B'_2 \rightarrow \bar{B}_2$ is an isomorphism (as B'_2 is contained in the ramification locus) while the morphism $B'_1 \rightarrow \bar{B}_1$ is a morphism of degree 2.

Recall that the branch locus of $X_\lambda^{31} \rightarrow \mathbb{P}^2(\mathbb{C})$ is the union of \bar{B}_2 and $R'_\lambda = \mathcal{Z}(r_\lambda)$. So

$$\bar{B}_2 \cap R'_\lambda = \{[z_1 : 0 : z_4] \in \mathbb{P}^2(\mathbb{C}) \mid z_4^3(z_1 - z_4)^2 = 0\}.$$

The set $\bar{B}_2 \cap R'_\lambda$ contains two points d_6 and a_3 of respective multiplicity 3 and 2 and whose coordinates are given by

$$d_6 = [1 : 0 : 0] \quad \text{and} \quad a_3 = [1 : 0 : 1].$$

They do not depend on λ . We will see in Corollary 6.14 and Proposition 6.15 that, if $\lambda \neq 0$, then d_6 is always a D_6 singularity of R_λ while a_3 is an A_3 singularity except whenever $\lambda = \lambda_2$ (in which case it is a D_5 singularity). ■

6.4. Singularities. We wish to determine the list of singularities of X_λ^{31} . We gather in the next proposition some helpful general facts, from which we can deduce the list of singularities of X_λ^{31} thanks to a few computations with MAGMA.

Proposition 6.13. *Let $v \in V \setminus \{0\}$ and let $z = [v]$. We assume that z is a smooth point of $\mathcal{Z}(f_{3,\lambda})$ and we denote by z' its image in X_λ^{31} .*

- (a) *If $|W_v| = 1$ or 2, then z' is smooth.*
- (b) *If $z \in B$ and W_v has rank 2, then $T_z(\mathcal{Z}(f_{3,\lambda}))$ together with its action of W_z does not depend on λ .*
- (c) *If P is a parabolic subgroup of rank 2 and if $z \in (\mathcal{Z}(f_{3,\lambda}) \setminus B) \cap \mathbb{P}(V^P)$, then $W_v = P$ and $W_z = P\langle w_4 \rangle$.*

Proof. (a) Assume first that $W_v = \{1\}$. Then $W_z = \langle w_{e_z} \rangle$ and 4 divides e_z (see [5, §4.1, Fact (a)]). Since e_z divides one of the degrees, we have $e_z \in \{4, 8, 12, 20, 24\}$. Note that $e_z \neq 20$ by Proposition 6.9.

If $e_z = 4$, then $(PW)_z = \{1\}$ and so z' is smooth. If $e_z \in \{8, 12, 24\}$, then $\delta(e_z) = \delta^*(e_z)$ and the eigenvalues of w_{e_z} on the tangent space $T_z(\mathcal{Z}(f_{3,\lambda}))$ are given by [5, Corollary 3.15(b)] and the determinant of w_{e_z} is given by (6.8). So we get:

- If $e_z = 8$, then $\det(w_{e_z}) = -1$ and so $W'_z = \langle w_8^2 \rangle = \langle w_4 \rangle$. So $(PW')_z = \{1\}$, which implies that z' is smooth.
- If $e_z = 12$, then $\det(w_{e_z}) = 1$ and the eigenvalues of w_{e_z} on $T_z(\mathcal{Z}(f_{3,\lambda}))$ are ζ_{12}^{-8} and $\zeta_{12}^{-24} = 1$, so w_{e_z} acts as a reflection on $T_z(\mathcal{Z}(f_{3,\lambda}))$. This implies that z' is smooth.

- If $e_z = 24$, then $\det(w_{e_z}) = -1$ so $W'_z = \langle w_{e_z}^2 \rangle$. Moreover, the eigenvalues of $w_{e_z}^2$ on $T_z(\mathcal{Z}(f_{3,\lambda}))$ are ζ_{24}^{-16} and $\zeta_{24}^{-24} = 1$, so $w_{e_z}^2$ acts as a reflection on $T_z(\mathcal{Z}(f_{3,\lambda}))$. This implies that z' is smooth.

This shows (a) whenever $W_v = \{1\}$.

Let us now assume that $|W_v| = 2$. Since w_{e_z} normalizes W_v , this means that w_{e_z} commutes with the non-trivial element of W_v , which is a reflection. But a MAGMA computation shows that w_e does not commute with any reflection if $e \in \{8, 12, 24\}$. So $e_z = 4$, which means that $(PW')_z = \{1\}$. So z' is smooth.

(b) Assume that $z \in B$ and that W_v has rank 2. Then $T_z(\mathcal{Z}(f_{3,\lambda}))$ is a dimension 2 subspace of $T_z(\mathbb{P}(V))$ which is stable under the action of W_v : but $T_z(\mathbb{P}(V)) = V/z$ endowed with the natural action of W_v which is of rank 2, so there is a unique W_v -stable dimension 2 subspace of $T_z(\mathbb{P}(V))$. This shows (b).

(c) Assume that P is a parabolic subgroup of rank 2 and that $z \in (\mathcal{Z}(f_{3,\lambda}) \setminus B) \cap \mathbb{P}(V^P)$. The fact that $z \notin B$ implies that $e_z \notin \{8, 12, 24\}$ by (6.10). This shows that $W_z = W_v \langle w_4 \rangle$. On the other hand, $P = W_v$ by (4.2). \square

Corollary 6.14. *If $\lambda \in \mathbb{C}$ is such that $\mathcal{Z}(f_{3,\lambda})$ is smooth, then X_λ^{31} has singularities $D_6 + A_3 + 3A_2 + 2A_1$.*

Proof. The previous proposition shows that it is sufficient to determine a set of representatives of conjugacy classes of parabolic subgroups P of rank 2 and to determine the action of W_z on $T_z(\mathcal{Z}(f_{3,\lambda}))$ for all $z \in \mathcal{Z}(f_{3,\lambda}) \cap \mathbb{P}(V^P)$. Let

$$W_{14} = \langle s_1, s_4 \rangle, \quad W_{15} = \langle s_1, s_5 \rangle \quad \text{and} \quad W_{123} = \langle s_1, s_2, s_3 \rangle.$$

We set $N_k = N_W(W_k)$ and $L_k = \mathbb{P}(V^{W_k})$ for $k \in \{14, 15, 123\}$. Computations with MAGMA show that:

- W_{14}, W_{15}, W_{123} are representatives of conjugacy classes of parabolic subgroups of rank 2.
- W_{14} is a Coxeter group of type A_2 and $|N_{14}/W_{14}\langle w_4 \rangle| = 6$. Moreover:
 - $L_{14} \cap B_1$ contains 2 elements which form a single N_{14} -orbit. If $z \in L_{14} \cap B_1$, then the action of W'_z on $T_z(\mathcal{Z}(f_{3,\lambda}))$ can be computed for a single value of λ thanks to Proposition 6.13(b), and it can be checked that it acts as a reflection group, so the image of z is smooth.
 - $L_{14} \cap B_2 = \emptyset$.
 - So it remains 18 points in $(\mathcal{Z}(f_{3,\lambda}) \setminus B) \cap L_{14}$: since the stabilizers of these points are equal to $W_{14}\langle w_4 \rangle$ by Proposition 6.13(c), their N_{14} -orbits have cardinality 6, so there are 3 such orbits, each leading to an A_2 -singularity because W_{14} is of type A_2 .
- W_{15} is a Coxeter group of type $A_1 \times A_1$ and $|N_{15}/W_{15}\langle w_4 \rangle| = 8$. Moreover:
 - $L_{15} \cap B_1 = \emptyset$.
 - $L_{15} \cap B_2$ contains 4 elements which form a single N_{15} -orbit. If $z \in L_{15} \cap B_2$, then the action of W'_z on $T_z(\mathcal{Z}(f_{3,\lambda}))$ can be computed for a single value of λ thanks to Proposition 6.13(b), and it can then be checked that the image of z is an A_3 -singularity.

- So it remains 16 points in $(\mathcal{Z}(f_{3,\lambda}) \setminus B) \cap L_{15}$: since the stabilizers of these points are equal to $W_{15}\langle w_4 \rangle$ by Proposition 6.13(c), their N_{15} -orbits have cardinality 8, so there are 2 such orbits, each leading to an A_1 -singularity because W_{15} is of type $A_1 \times A_1$.
- W_{123} is a complex reflection group of type $G(4, 2, 2)$ and $|N_{123}/W_{123}\langle w_4 \rangle| = 24$. Moreover:
 - $L_{123} \cap B_1$ contains 8 elements which form a single N_{123} -orbit. Again, Proposition 6.13(b) allows an easy computation which implies that the image of z is smooth.
 - $L_{123} \cap B_2$ contains 12 elements which form a single N_{123} -orbit. Again, Proposition 6.13(b) allows an easy computation which implies that the image of z is a D_6 -singularity.
 - It remains no point in $(\mathcal{Z}(f_{3,\lambda}) \setminus B) \cap L_{123}$.

The proof of the corollary is complete. \square

Proposition 6.15. *If $k \in \{145, 245, 1, 2, 3\}$, then the singularities of $X_{\lambda_k}^{31}$ are given by Table II, i.e.*

- (a) *The surface $X_{\lambda_{145}}^{31} = X_{-8/25}^{31}$ has singularities $D_6 + D_5 + A_3 + 2A_2$.*
- (b) *The surface $X_{\lambda_{245}}^{31} = X_{-81/175}^{31}$ has singularities $E_6 + D_6 + A_3 + A_2 + A_1$.*
- (c) *The surface $X_{\lambda_1}^{31} = X_1^{31}$ has singularities $D_6 + A_5 + A_3 + A_2 + 2A_1$.*
- (d) *The surface $X_{\lambda_2}^{31} = X_{-1/3}^{31}$ has singularities $D_6 + D_5 + 3A_2 + A_1$.*
- (e) *The surface $X_{\lambda_3}^{31} = X_{-1/2}^{31}$ has singularities $D_6 + 2A_3 + 2A_2 + 2A_1$.*

Proof. Using the formula for r_λ given in the previous subsection, one can easily obtain the equation of the branch locus R_{λ_k} for the five values of k . The singularities of the curve R_{λ_k} are then easily determined thanks to MAGMA and we conclude thanks to [5, Proposition 4.4]. \square

This has the following consequence, which confirms some of the results of Table II:

Corollary 6.16. *Let $\lambda \in \mathbb{C}^\times$. Then:*

- (a) *If $\lambda \notin \{\lambda_{145}, \lambda_{245}, \lambda_1, \lambda_2, \lambda_3\}$, then $\rho(\tilde{X}_\lambda^{31}) \geq 18$.*
- (b) *For generic λ , we have $\rho(\tilde{X}_\lambda^{31}) = 18$.*
- (c) *If $\lambda \in \{\lambda_{145}, \lambda_{245}, \lambda_1, \lambda_2, \lambda_3\}$, then $\rho(\tilde{X}_\lambda^{31}) = 19$.*

Proof. Let $\lambda \in \mathbb{C}^\times$. We denote by m the sum of the Milnor numbers of the singularities of X_λ^{31} (i.e., m is the number of smooth rational curves in the exceptional divisors of the resolution $\pi_\lambda : \tilde{X}_\lambda^{31} \rightarrow X_\lambda^{31}$). Then $\rho(\tilde{X}_\lambda^{31}) \geq 1 + m$ since X_λ^{31} is projective, so one can check from Corollary 6.14 and Proposition 6.15 the following two facts:

$$(\clubsuit) \quad \begin{cases} \text{If } \lambda \notin \{\lambda_{145}, \lambda_{245}, \lambda_1, \lambda_2, \lambda_3\}, \text{ then } \rho(\tilde{X}_\lambda^{31}) \geq 18; \\ \text{If } \lambda \in \{\lambda_{145}, \lambda_{245}, \lambda_1, \lambda_2, \lambda_3\}, \text{ then } \rho(\tilde{X}_\lambda^{31}) \geq 19. \end{cases}$$

Note that (♣) proves the inequality stated in (a).

Let us now prove the equalities stated in (b) and (c). We shall use the methods developed by van Luijk [30] and Elsenhans and Jahnel [12, §3.3.1], based on the Artin-Tate Conjecture (proved by Nygaard and Ogus for K3 surfaces [20] in characteristic ≥ 5), but we adapt them to the singular case. For this, assume that $\lambda \in \mathbb{Q}$ and let \mathcal{P}_λ denote the set of prime numbers p such that:

- (1) $p \geq 5$ and p does not divide any denominator of any coefficient of r_λ . (so that we can define a reduction of X_λ^{31} modulo p , which will be defined over \mathbb{F}_p and will be denoted by $(X_\lambda^{31})_p$: we also denote by $(R_\lambda)_p$ the reduction modulo p of the ramification locus of π_λ).
- (2) If \mathcal{O}_λ is the ring of integers of the minimal number field K_λ containing the coordinates of all the singular points of X_λ^{31} and if \mathfrak{p}_λ is a prime ideal of \mathcal{O}_λ lying over p , then $\mathcal{O}_\lambda/\mathfrak{p}_\lambda = \mathbb{F}_p$ and all the singular points of $(X_\lambda^{31})_p$ have coordinates in \mathbb{F}_p and are the reduction modulo \mathfrak{p}_λ of the singular points of X_λ^{31} .
- (3) If $x \in X_\lambda^{31}$ is a singular point, then its reduction modulo p is an ADE singularity of $(X_\lambda^{31})_p$ of the same type as x .

So let $p \in \mathcal{P}_\lambda$. We denote by $(\tilde{X}_\lambda^{31})_p$ the minimal resolution of the K3 surface $(X_\lambda^{31})_p$. Then $(\tilde{X}_\lambda^{31})_p$ is the reduction modulo p of X_λ^{31} by (1), (2) and (3), because $(\tilde{X}_\lambda^{31})_p$ is obtained from X_λ^{31} by the same sequence of blow-ups. This shows in particular that \tilde{X}_λ^{31} has good reduction modulo p (i.e. remains smooth) and that its reduction modulo p is exactly $(\tilde{X}_\lambda^{31})_p$.

We denote by $P_{\lambda,p} \in \mathbb{Z}[T]$ (resp. $\tilde{P}_{\lambda,p} \in \mathbb{Z}[T]$) the Weil polynomial of $(X_\lambda^{31})_p$ (resp. $(\tilde{X}_\lambda^{31})_p$), namely the characteristic polynomial of the Frobenius map on the second ℓ -adic cohomology group of $(X_\lambda^{31})_p$ (resp. $(\tilde{X}_\lambda^{31})_p$). Note that the polynomial $P_{\lambda,p}$ can be computed explicitly (and efficiently!) thanks to the command `WeilPolynomialOfDegree2K3Surface` in MAGMA and that

$$(\diamond) \quad \tilde{P}_{\lambda,p} = (T - p)^m P_{\lambda,p},$$

where we recall that m is the number of irreducible components of the exceptional divisors of the minimal resolution of X_λ^{31} (or of $(X_\lambda^{31})_p$, as they are all defined over \mathbb{F}_p by (2) and (3)). Let $\rho_{\lambda,p}$ denote the $(T - p)$ -valuation of $P_{\lambda,p}$ and let $Q_{\lambda,p} = P_{\lambda,p}/(T - p)^{\rho_{\lambda,p}}$. Let $\rho_{\lambda,p}^g$ denote the number of root of $Q_{\lambda,p}$ of the form ζp , where ζ is a root of unity (note that $\rho_{\lambda,p}^g \geq \rho_{\lambda,p}$). Also, we denote by $D_\lambda \in \mathbb{Q}^\times$ the discriminant of the Picard group of X_λ^{31} .

We denote by $\text{Pic}_g((\tilde{X}_\lambda^{31})_p)$ the geometric Picard group of $(\tilde{X}_\lambda^{31})_p$, namely the Picard group of $\overline{\mathbb{F}}_p \times_{\mathbb{F}_p} (\tilde{X}_\lambda^{31})_p$. Then Artin-Tate Conjecture and (\diamond) say that

$$(\heartsuit) \quad m + \rho_{\lambda,p} = \text{rk Pic}((\tilde{X}_\lambda^{31})_p) \quad \text{and} \quad m + \rho_{\lambda,p}^g = \text{rk Pic}_g((\tilde{X}_\lambda^{31})_p).$$

Reduction modulo p induces an injective map $\text{Pic } \tilde{X}_\lambda^{31} \hookrightarrow \text{Pic}_g((\tilde{X}_\lambda^{31})_p)$ (see [29, Proposition 6.2]). Hence

$$(\spadesuit) \quad \rho(\tilde{X}_\lambda^{31}) \leq m + \rho_{\lambda,p}^g.$$

Moreover, if these two groups have the same rank, then their discriminant are equal modulo $\mathbb{Q}^{\times 2}$. By Artin-Tate Conjecture and (\heartsuit) , this forces

$$(\spadesuit^+) \quad \text{If } \rho(\tilde{X}_\lambda^{31}) = m + \rho_{\lambda,p}^g = m + \rho_{\lambda,p}, \text{ then } D_\lambda \equiv p^{m + \rho_{\lambda,p}^g - 21} Q_{\lambda,p}(p) \pmod{\mathbb{Q}^{\times 2}}.$$

With all these tools in hand, we proceed as follows (numerical results stated below are obtained with MAGMA).

(b) By (\clubsuit) , $\rho(\tilde{X}_{-1/4}^{31}) \geq 18$. Note that $m = 17$ in this case. On the other hand, $193 \in \mathcal{P}_{-1/4}$ and

$$P_{-1/4,193} = (T - 193)(T^4 + 212T^3 + 10422T^2 + 7896788T + 1387488001).$$

This shows that $Q_{-1/4,193} = T^4 + 212T^3 + 10422T^2 + 7896788T + 1387488001$. Since this polynomial has no root of the form 193ζ with ζ a root of unity, we get that $\rho_{-1/4,193} = \rho_{-1/4,193}^g = 1$ and so $\rho(\tilde{X}_{-1/4}^{31}) \leq 18$ by (\spadesuit) . This proves (b) for $\lambda = -1/4$ and so this proves (b) for λ generic.

(c) We explain how to prove (c) whenever $\lambda = \lambda_{145} = -8/25$, the other cases being treated similarly. Note first that $m = 18$ in this case. By (\clubsuit) , $\rho(\tilde{X}_{-8/25}) \in \{19, 20\}$. Note that 23 and 47 belong to $\mathcal{P}_{-8/25}$. We have

$$\begin{aligned} P_{-8/25,23} &= (T - 23)^2(T^2 + 38T + 529) & \text{and} & & Q_{-8/25,23}(23)/23 &\equiv 21 \pmod{\mathbb{Q}^{\times 2}}, \\ P_{-8/25,47} &= (T - 47)^2(T^2 + 22T + 2209) & \text{and} & & Q_{-8/25,47}(47)/47 &\equiv 29 \pmod{\mathbb{Q}^{\times 2}}. \end{aligned}$$

Assume that $\rho(\tilde{X}_{-8/25}) = 20$. Then

$$20 = \rho(\tilde{X}_{-8/25}) = m + \rho_{-8/25,23} = m + \rho_{-8/25,23}^g = m + \rho_{-8/25,47} = m + \rho_{-8/25,47}^g,$$

so it follows from (\spadesuit^+) that $21 \equiv 29 \pmod{\mathbb{Q}^{\times 2}}$, which is impossible. So $\rho(\tilde{X}_{-8/25}^{31}) = 19$, as expected. \square

Remark 6.17 (Supersingular surfaces). Keep the notation of the proof of Corollary 6.16. For each exceptional value of λ (i.e. $\lambda \in \{\lambda_{145}, \lambda_{245}, \lambda_1, \lambda_2, \lambda_3\}$) there exist prime numbers p such that \tilde{X}_λ^{31} has good reduction modulo p and $(\tilde{X}_\lambda^{31})_p$ is a supersingular variety (i.e. has geometric Picard number 22). We give here a (non-exhaustive) list of examples. So assume that (λ, p) is a pair where $\lambda \in \{\lambda_{145}, \lambda_{245}, \lambda_1, \lambda_2, \lambda_3\}$ and p is a prime number such that:

- If $\lambda = \lambda_{145} = -8/25$, then $p \in \{59, 73, 89\}$.
- If $\lambda = \lambda_{245} = -81/175$, then $p \in \{31, 47, 73\}$.
- If $\lambda = \lambda_1 = 1$, then $p = 43$.
- If $\lambda = \lambda_2 = -1/3$, then $p = 337$.
- If $\lambda = \lambda_3 = -1/2$, then $p \in \{73, 79\}$.

Then $(\tilde{X}_\lambda^{31})_p$ is supersingular. \blacksquare

Remark 6.18. Note that, generically, r_λ is irreducible. However, r_{λ_1} and r_{λ_3} are not irreducible⁴:

- The quintic $R'_{\lambda_1} = R'_1$ is the union of a smooth irreducible conic and an irreducible cubic. More detail about this case will be given in §7.4.2.
- The quintic $R'_{\lambda_3} = R'_{-1/2}$ is the union of a line and an irreducible quartic. More detail about this case will be given in §7.4.3. \blacksquare

⁴We do not know if there are other values of λ such that r_λ is not irreducible.

6.5. Complements. The experienced reader might have noticed that

$$f_1 = \Sigma(x^8) + 14\Sigma(x^4y^4) + 168x^2y^2z^2t^2$$

is the polynomial which defines the smooth octic containing 352 lines constructed by Boissière and the second author [2]. We will revisit here this example.

Let

$$\sigma = \frac{\sqrt{2}}{2} \begin{pmatrix} -1 & 0 & 0 & -1 \\ 0 & 1 & 1 & 0 \\ 0 & 1 & -1 & 0 \\ -1 & 0 & 0 & 1 \end{pmatrix}.$$

Then $\sigma(s_i) = s_{5-i}$ if $i \in \{1, 2, 3, 4\}$ and $\zeta_8\sigma \in G_{31}$. Moreover, $\zeta_8\sigma$ normalizes the subgroup G_{28} . In [2], the polynomial f_1 was constructed as a particular invariant of the one-parameter family of fundamental invariants of degree 8 of the group $\langle \sigma \rangle \times G_{28}^{\text{SL}}$ (which is contained in $\langle \zeta_8 \rangle G_{31}$), but it turns out that this is exactly the one which is invariant by G_{31} .

The 352 lines on $\mathcal{Z}(f_1)$ are divided into two G_{31} -orbits: one of size 160 and one of size 192. We explain here how to construct these two orbits.

First, as 12 does not divide 8, the G_{31} -orbit of L_{12} is contained in $\mathcal{Z}(f_1)$ by [5, Lemma 2.2], so this explains the first orbit with 160 lines. For constructing the second orbit, one requires some more material. Let $\mathcal{W} = G_{37} = W(E_8)$ acting on a vector space V_8 of dimension 8. The list of degrees (resp. codegrees) of \mathcal{W} is $(2, 8, 12, 14, 18, 20, 24, 30)$ (resp. $(0, 6, 10, 12, 16, 18, 22, 28)$). Applying Theorem 3.13 with \mathcal{W} and $e = 4$ shows that there exists an element $w_4 \in \mathcal{W}$ such that $\dim V_8(w_4, i) = 4$, $\mathcal{W}(V_8(w_4, i)) = \{1\}$ and $\mathcal{W}_{V_8(w_4, i)}$ acts on $V_8(w_4, i)$ as a reflection group whose list of degrees is $(8, 12, 20, 24)$: in fact, $\mathcal{W}_{V_8(w_4, i)} \simeq G_{31}$ (as a reflection group). Therefore, we may identify V with $V_8(w_4, i)$ and G_{31} with $\mathcal{W}_{V_8(w_4, i)}$.

Now, let $\phi = (1 + \sqrt{5})/2$ be the golden ratio. By [15, §3], there exists an automorphism φ of V_8 satisfying $\varphi^2 = \varphi + \text{Id}_{V_8}$ and such that $\dim V_8(\varphi, \phi) = 4$ and $\mathcal{W}_{V_8(\varphi, \phi)}$ acts faithfully on $V_8(\varphi, \phi)$ as the complex reflection group $W(H_4) = G_{30}$. Using again Theorem 3.13 with $\mathcal{W}_{V_8(\varphi, \phi)} \simeq G_{30}$, we see that we may choose the above element v as belonging to $\mathcal{W}_{V_8(\varphi, \phi)}$. Moreover, $E = V_8(v, i) \cap V_8(\varphi, \phi)$ has dimension 2, and its stabilizer \mathcal{W}_E acts faithfully on E as the complex reflection group G_{22} , whose list of degrees is $(12, 20)$ (as they are the only degrees of W which are divisible by 4). Hence, the restriction of f_1 to E having degree 8 and being invariant under $\mathcal{W}_E = C_W(w_4)$, this implies that f_1 vanishes on E . So, if we let $L' = \mathbb{P}(E)$, then L' is a line contained in $\mathcal{Z}(f_1)$, whose stabilizer in G_{31} has order $12 \times 20 = 240$. This shows that the G_{31} -orbit of L' contains 192 lines which are all contained in $\mathcal{Z}(f_1)$.

7. THE GROUP G_{31} (CONTINUED): ELLIPTIC FIBRATIONS

We will use here the constructions of Appendix B. Let x be a singular point of the branch locus R_λ . Since x belongs to the branch locus, there is a unique point $\dot{x} \in X_\lambda^{31}$ above x . Let $p_x : \mathbb{P}^2(\mathbb{C}) \setminus \{x\} \rightarrow \mathbb{P}^1(\mathbb{C})$ be the projection from the point x . We denote by $\hat{\mathbb{P}}_x^2(\mathbb{C})$ the blow-up of $\mathbb{P}^2(\mathbb{C})$ at x and by \hat{X}_λ^x the blow-up of X_λ^{31} at \dot{x} . Then:

- The projection p_x lifts and extends to a morphism $\hat{p}_x : \hat{\mathbb{P}}_x^2(\mathbb{C}) \rightarrow \mathbb{P}^1(\mathbb{C})$.

- Since X_λ^{31} has only ADE singularities, the map $\xi_\lambda : X_\lambda^{31} \rightarrow \mathbb{P}^2(\mathbb{C})$ lifts to a map $\hat{\xi}_\lambda^x : \hat{X}_\lambda^x \rightarrow \hat{\mathbb{P}}_x^2(\mathbb{C})$ (see Proposition B.1).
- Since X_λ^{31} has only ADE singularities, its minimal resolution is obtained by successive blow-ups of singular points. In particular, the morphism $\pi_\lambda : \tilde{X}_\lambda^{31} \rightarrow X_\lambda^{31}$ factorizes through $\hat{\pi}_\lambda^x : \tilde{X}_\lambda^{31} \rightarrow \hat{X}_\lambda^x$.

Altogether, this gives a well-defined morphism of varieties

$$\tilde{\varphi}_\lambda^x = \hat{p}_x \circ \hat{\xi}_\lambda^x \circ \hat{\pi}_\lambda^x : \tilde{X}_\lambda^{31} \rightarrow \mathbb{P}^1(\mathbb{C}),$$

i.e. an elliptic fibration.

This gives lots of elliptic fibrations, and the particular values λ_k of λ must also be treated separately. For this reason, we will not compute the singular fibers in all cases. We will just provide general facts about sections, use them to determine the intersection graph of the curves contained in $\pi_\lambda^{-1}(B'_2)$ and just focus on singular fibers of the fibration $\tilde{\varphi}_\lambda^{d_6}$.

Question. *Are there other elliptic fibrations on the surface \tilde{X}_λ^{31} ?*

7.1. Sections. Let us first discuss the question of sections of the elliptic fibration associated with $\tilde{\varphi}_\lambda^x$, using Proposition B.3. For this, let \hat{E}_x denote the exceptional divisor of the blow-up $\hat{\mathbb{P}}_x^2(\mathbb{C})$ (it is isomorphic to $\mathbb{P}^1(\mathbb{C})$ and maps isomorphically to $\mathbb{P}^1(\mathbb{C})$ through \hat{p}_x). If we denote by m the Milnor number of \hat{x} and by $\Delta_1^x, \dots, \Delta_m^x$ the smooth rational curves of the exceptional divisor of \hat{X}_λ^x , then Proposition B.3 implies that:

- If $m \geq 2$ and x is an A_m -singularity (and if we assume that the smooth rational curves Δ_j^x are numbered so that the extremal vertices of their intersection graph are Δ_1^x and Δ_m^x , then Δ_1^x and Δ_m^x are exchanged by σ and are mapped isomorphically to \hat{E}_x . This gives two sections $\theta_x^\pm : \mathbb{P}^1(\mathbb{C}) \rightarrow \tilde{X}_\lambda^{31}$ of the elliptic fibration $\tilde{\varphi}_\lambda^x$ satisfying $\theta_x^- = \sigma \circ \theta_x^+$.
- If x is not of type A , then only one of the smooth rational curves Δ_j^x maps isomorphically to \hat{E}_x . This leads to a section $\theta_x : \mathbb{P}^1(\mathbb{C}) \rightarrow \tilde{X}_\lambda^{31}$ of $\tilde{\varphi}_\lambda^x$.

Note also that any line L of $\mathbb{P}^2(\mathbb{C})$ not containing x maps isomorphically through the projection p_x , so its inverse image $\hat{L} \simeq L$ in $\hat{\mathbb{P}}_x^2(\mathbb{C})$ maps isomorphically to $\mathbb{P}^1(\mathbb{C})$ through \hat{p}_x . Applied to the line \bar{B}_2 , and using the fact that \bar{B}_2 lies in the branch locus (and so the map $B'_2 \rightarrow \bar{B}_2$ is an isomorphism), we see that, if $x \notin \bar{B}_2$, then the elliptic fibration $\tilde{\varphi}_\lambda^x$ admits a section $\theta_x^B : \mathbb{P}^1(\mathbb{C}) \rightarrow \tilde{X}_\lambda^{31}$ whose image is the strict transform \bar{B}'_2 of B'_2 in \tilde{X}_λ^{31} . We summarize the above discussion in the next proposition:

Proposition 7.1. *Let x be a singular point of R_λ . Then:*

- If $m \geq 2$ and if x is an A_m singularity, then the elliptic fibration $\tilde{\varphi}_\lambda^x$ admits two sections θ_x^\pm whose images are the two extremal smooth rational curves of the exceptional divisor $\hat{\pi}_\lambda^{-1}(\hat{x})$.*
- If x is not a type A singularity, then the elliptic fibration $\tilde{\varphi}_\lambda^x$ admits a section whose image is one of the smooth rational curves of the exceptional divisor $\hat{\pi}_\lambda^{-1}(\hat{x})$.*
- If $x \notin \bar{B}_2$ (i.e. if $x \notin \{a_3, d_6\}$), then the elliptic fibration $\tilde{\varphi}_\lambda^x$ admits a section whose image is \bar{B}'_2 .*

7.2. Intersection graph in $\pi_\lambda^{-1}(B'_2)$ and the elliptic fibration $\tilde{\varphi}_\lambda^{a_3}$. Recall that a_3 and d_6 are the only singular points of R_λ belonging to B'_2 . It will be interesting for computing Picard numbers and transcendental lattices to determine the intersection graph between the smooth rational curves of $\pi_\lambda^{-1}(d_6)$, the ones of $\pi_\lambda^{-1}(a_3)$ and the strict transform \tilde{B}'_2 of B'_2 in \tilde{X}_λ^{31} . This will be done thanks to the elliptic fibrations constructed in this section. We need some notation. The point $\dot{d}_6 \in X_\lambda^{31}$ is always a D_6 singularity. We assume that the 6 smooth rational curves $(\Delta_k^{d_6})_{1 \leq k \leq 6}$ of the exceptional divisor $\pi_\lambda^{-1}(\dot{d}_6)$ are numbered in such a way that the intersection graph is given by

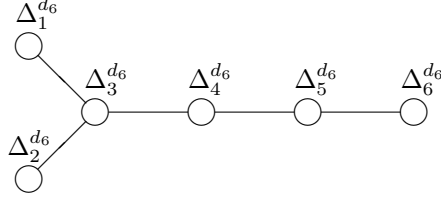

We denote by $m_3(\lambda)$ the Milnor number of the singularity \dot{a}_3 . If $\lambda \neq \lambda_2 = -1/3$ (resp. $\lambda = \lambda_2$), then a_3 is an A_3 (resp. a D_5) singularity, so $m_3(\lambda) = 3$ (resp. $m_3(\lambda) = 5$) and we assume that the $m_3(\lambda)$ smooth rational curves $(\Delta_k^{a_3})_{1 \leq k \leq m_3(\lambda)}$ of the exceptional divisor $\pi_\lambda^{-1}(\dot{a}_3)$ are numbered in such a way that the intersection graph is given by

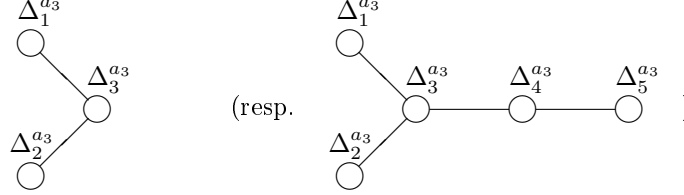

Now, if x is a singular point of X_λ^{31} different from a_3 and d_6 (there always exists such a point), then $(\tilde{\varphi}_\lambda^x)^{-1}(p_x(d_6))$ and $(\tilde{\varphi}_\lambda^x)^{-1}(p_x(a_3))$ are two singular fibers (because they contain $\pi_\lambda^{-1}(\dot{d}_6)$ and $\pi_\lambda^{-1}(\dot{a}_3)$). Since \tilde{B}'_2 is a section of the elliptic fibration $\tilde{\varphi}_\lambda^x$ by Proposition 7.1, \tilde{B}'_2 meets $\pi_\lambda^{-1}(\dot{d}_6)$ and $\pi_\lambda^{-1}(\dot{a}_3)$ transversally at only one curve with multiplicity 1. Recall that the multiplicity 1 curves of $\pi_\lambda^{-1}(\dot{d}_6)$ (resp. $\pi_\lambda^{-1}(\dot{a}_3)$) are $\Delta_1^{d_6}, \Delta_2^{d_6}$ and $\Delta_6^{d_6}$ (resp. $\Delta_1^{a_3}, \Delta_2^{a_3}$ and $\Delta_{m_3(\lambda)}^{a_3}$, where $m_3(\lambda)$ denote the Milnor number of the singularity \dot{a}_3).

Since $\sigma(\tilde{B}'_2) = \tilde{B}'_2$ and $\sigma(\Delta_1^{a_3}) = \Delta_2^{a_3}$, this forces that \tilde{B}'_2 meets $\pi_\lambda^{-1}(\dot{a}_3)$ transversally at $\Delta_{m_3(\lambda)}^{a_3}$.

To determine which curve of $\pi_\lambda^{-1}(\dot{d}_6)$ meets \tilde{B}'_2 , we use the elliptic fibration $\tilde{\varphi}_\lambda^{a_3}$. First, $(\tilde{\varphi}_\lambda^{a_3})^{-1}(p_{a_3}(d_6))$ contains $\pi_\lambda^{-1}(\dot{d}_6)$ and \tilde{B}'_2 . Moreover, $\tilde{\varphi}_\lambda^{a_3}(\Delta_{m_3(\lambda)}^{a_3})$ is a point by Proposition B.3, so it must be the same point as $\tilde{\varphi}_\lambda^{a_3}(\tilde{B}'_2)$, which is $\tilde{\varphi}_\lambda^{a_3}(\dot{d}_6) = p_{a_3}(d_6)$. Therefore,

$$(\tilde{\varphi}_\lambda^{a_3})^{-1}(p_{a_3}(d_6)) = \Delta_{m_3(\lambda)}^{a_3} \cup \tilde{B}'_2 \cup \left(\bigcup_{k=1}^6 \Delta_k^{d_6} \right).$$

The Kodaira-Néron classification of singular fibers then shows that the only possibility is that $(\tilde{\varphi}_\lambda^{a_3})^{-1}(p_{a_3}(d_6))$ is of type \tilde{E}_7 and \tilde{B}'_2 meets $\Delta_1^{d_6}$ (by exchanging $\Delta_1^{d_6}$ and $\Delta_2^{d_6}$ if necessary). So we have shown most of the following lemma:

Lemma 7.2. *The intersection graph of curves contained in $\pi_\lambda^{-1}(B'_2)$ is as follows. If $\lambda \neq \lambda_2$ it is given by*

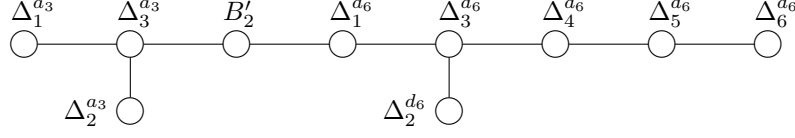

and if $\lambda = \lambda_2$ it is given by

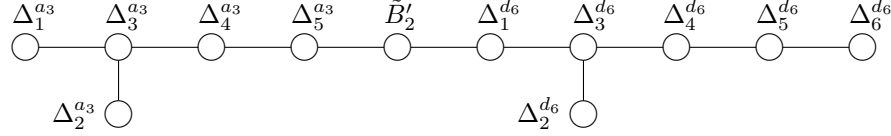

Moreover:

- (a) *The singular fiber $(\tilde{\varphi}_\lambda^{a_3})^{-1}(p_{a_3}(d_6))$ is of type \tilde{E}_7 .*
- (b) *The singular fiber $(\tilde{\varphi}_\lambda^{d_6})^{-1}(p_{d_6}(a_3))$ is of type \tilde{D}_7 if $\lambda \neq \lambda_2$ and of type \tilde{D}_9 if $\lambda = \lambda_2 = -1/3$.*

Proof. Only the statement (b) has not been proved. First, $\pi_\lambda^{-1}(a_3)$ and \tilde{B}'_2 are contained in $(\tilde{\varphi}_\lambda^{d_6})^{-1}(p_{d_6}(a_3))$. Moreover, it follows from Proposition B.3 that the curves $(\Delta_k^{d_6})_{1 \leq k \leq 4}$ are sent, through $\tilde{\varphi}_\lambda^{d_6}$, to a single point of $\mathbb{P}^1(\mathbb{C})$. Since \tilde{B}'_2 meets $\Delta_1^{d_6}$, this point is necessarily $p_{d_6}(a_3)$. So

$$(\tilde{\varphi}_\lambda^{d_6})^{-1}(p_{d_6}(a_3)) = \pi_\lambda^{-1}(a_3) \cup \tilde{B}'_2 \cup \left(\bigcup_{k=1}^4 \Delta_k^{d_6} \right),$$

and the result follows from the description of the intersection graph. \square

7.3. The elliptic fibration $\tilde{\varphi}_\lambda^{d_6}$. Since $d_6 = [1 : 0 : 0]$, the maps $p_{d_6} : \mathbb{P}^2(\mathbb{C}) \setminus \{d_6\} \rightarrow \mathbb{P}^1(\mathbb{C})$ and $\varphi_{d_6} : X_\lambda^{31} \setminus \{d_6\} \rightarrow \mathbb{P}^1(\mathbb{C})$ are easily described by

$$p_{d_6}([z_1 : z_2 : z_4]) = [z_2 : z_4] \quad \text{and} \quad \varphi_{d_6}([z_1 : z_2 : z_4 : t]) = [z_2 : z_4].$$

Since d_6 is a D_6 -singularity of X_λ^{31} , the reduced fiber $(\hat{\pi}_\lambda^{d_6})^{-1}(d_6)$ is isomorphic to $\mathbb{P}^1(\mathbb{C})$ and contains two singular points of \hat{X}_λ^{31} : one, which we denote by a , is an A_1 singularity and the other, which we denote by b , is a D_4 -singularity. A MAGMA computation shows that

$$\hat{\varphi}_{d_6}(a) = [1 : -4\lambda(\lambda + 1)] \quad \text{and} \quad \hat{\varphi}_{d_6}(b) = [0 : 1] = \varphi_{d_6}(a_3).$$

The singular fiber above $[0 : 1]$ has been described in Lemma 7.2(b) so we concentrate now on the fiber above $[1 : -4\lambda(\lambda + 1)]$.

We denote by Δ_λ the closure of $\varphi_{d_6}^{-1}([1 : -4\lambda(\lambda + 1)])$ in X_λ^{31} : if we denote by $s_\lambda(z_1, z_2)$ the quadratic form

$$s_\lambda(z_1, z_2) = z_1^2 + (-71\lambda^2 - 52\lambda - 8)z_1z_2 + (8\lambda^4 + 28\lambda^3 + 36\lambda^2 + 20\lambda + 4)z_2^2,$$

we have

$$\begin{aligned}\Delta_\lambda &= \{[z_1 : z_2 : z_4 : t] \in X_\lambda^{31} \mid z_4 = -4\lambda(\lambda + 1)z_2\} \\ &\simeq \{[z_1 : z_2 : t] \in \mathbb{P}(1, 1, 3) \mid t^2 = z_2 r_\lambda(z_1, z_2, -4\lambda(\lambda + 1)z_2)\} \\ &= \{[z_1 : z_2 : t] \in \mathbb{P}(1, 1, 3) \mid t^2 = -16\lambda^3(2\lambda + 1)^3 z_2^4 s_\lambda(z_1, z_2)\}.\end{aligned}$$

Note the following fact:

Lemma 7.3. *If $\lambda \neq 0, -1/2, -8/17$, then the closed subvariety Δ_λ meets the singular locus of X_λ^{31} at only one point (the point \hat{d}_6).*

Proof. This is a MAGMA computation. □

Let $\tilde{\Delta}_\lambda$ denote the strict transform of Δ_λ in \tilde{X}_λ^{31} , recall that $\Delta_6^{d_6} = (\hat{\pi}_\lambda^{d_6})^{-1}(a)$ and let \mathcal{E}_λ denote the fiber $(\tilde{\varphi}_\lambda^{d_6})^{-1}([1 : -4\lambda(\lambda + 1)])$. Then it follows from Lemma 7.3 that:

Corollary 7.4. *If $\lambda \neq 0, -1/2, -8/17$, then $\mathcal{E}_\lambda = \tilde{\Delta}_\lambda \cup \Delta_6^{d_6}$.*

However, it must be noticed that Δ_λ is not necessarily irreducible. Indeed,

$$s_\lambda = \left(z_1 - \frac{71\lambda^2 + 52\lambda + 8}{2} z_2\right)^2 - \lambda \left(\frac{17\lambda + 8}{4}\right)^3 z_2^2.$$

So Δ_λ is irreducible if and only if $\lambda \neq 0, -8/17$ (we retrieve the same special value as in Lemma 7.3). We deduce from this the following result:

Corollary 7.5. *If $\lambda \neq 0, -1/2, -8/17$, then \mathcal{E}_λ is a singular fiber of type I_2*

Proof. The hypothesis implies that \mathcal{E}_λ contains two irreducible components, namely $\tilde{\Delta}_\lambda$ and $\Delta_6^{d_6}$. It then follows from the classification of singular fibers that \mathcal{E}_λ is of type I_2 or III.

Now, let $\hat{\Delta}_\lambda$ denote the strict transform of Δ_λ in \hat{X}_λ^{31} . From the equation of Δ_λ , we see that d_6 is an A_3 singularity of Δ_λ so that, after blowing-up, a is an A_1 singularity of $\hat{\Delta}_\lambda$. So, after blowing-up a , we see that $\hat{\Delta}_\lambda$ meets $\Delta_6^{d_6}$ in two different points, so that \mathcal{E}_λ is of type \hat{A}_1 . □

Proposition 7.6. *Let $\lambda \in \mathbb{C}^\times$. Then the singular fibers of $\tilde{\varphi}_\lambda^{d_6}$ are given by Table IV.*

Proof. Assume first that $\lambda \neq -1/2, -8/17$. Then a MAGMA computation shows that, if x and y are two different singular points of $X_\lambda^{31} \setminus \{\dot{d}_6\}$, then $\varphi_{d_6}(x) \neq \varphi_{d_6}(y)$. Then the result follows from Lemmas 7.2(b) and 7.3 and the same argument based on Euler characteristic in the proof of Corollary 5.11 to distinguish between the different possibilities.

The case where $\lambda = -1/2$ will be treated in §7.4.3. So it remains to check the case where $\lambda = -8/17$. The numerical facts in what follows can be checked with MAGMA [7, ??]. Whenever $\lambda = -8/17$, then $\Delta_{-8/17}$ is not irreducible and contains one of the A_2 singularities of $X_{-8/17}^{31}$ (let us call it \dot{a}_2), the singularity \dot{d}_6 and no other singular points of $X_{-8/17}^{31}$. and splits into two irreducible components which we call $\Delta_{-8/17}^1$ and $\Delta_{-8/17}^2$. Their intersection contains only the points \dot{d}_6 and \dot{a}_2 . One can check that they are both smooth at \dot{a}_3 and that the tangent line of $\Delta_{-8/17}^1$ at \dot{a}_2 is different than the one of $\Delta_{-8/17}^2$. Therefore, $\mathcal{E}_{-8/17}$ is the union of five irreducible components $\Delta_6^{d_6}, \tilde{\Delta}_{-8/17}^1, \tilde{\Delta}_{-8/17}^2, \Delta_1^{a_2}$ and $\Delta_2^{a_2}$ and the last four form an A_4 configuration whose extremal curves are $\tilde{\Delta}_{-8/17}^1$ and $\tilde{\Delta}_{-8/17}^2$. Since these extremal curves both meet $\Delta_6^{d_6}$, the only possibility for the singular fiber $(\tilde{\varphi}_\lambda^{d_6})^{-1}(\varphi_{d_6}(\dot{a}_2))$ is to be of type \tilde{A}_4 . The other singular fibers are obtained as in the previous case, using again Euler characteristic to remove ambiguities. \square

Recall from Proposition 7.1(b) that the elliptic fibration $\tilde{\varphi}_\lambda^{d_6}$ admits a section whose image is $\Delta_5^{d_6}$:

Proposition 7.7. *Let $\lambda \in \mathbb{C}^\times$. Then the Mordell-Weil group $\text{MW}(\tilde{\varphi}_\lambda^{d_6})$ is given by Table IV.*

Proof. In all cases, the rank of the Mordell-Weil group is equal to 0. The torsion is given by [26]. \square

We summarize all the datas collected in this section and the previous one in Table IV. Observe that in all the cases except when the Mordell-Weil group has torsion, the Picard group of the K3 surface is $U + (\text{Dynkin diagram of the singular fibers})$, i.e. in the generic cas is $U + D_7 + 3A_2 + 3A_1$. In the case when the Mordell-Weil group is $\mathbb{Z}/2\mathbb{Z}$ then one has to add the 2-torsion section to get the whole Picard group.

7.4. Three particular cases. We study here the cases where $\lambda \in \{-8/17, 1, -1/2\}$, which are all particular in their own way.

| λ | $\mathcal{L}_{\text{sing}}(f_{3,\lambda})$ | singularities of X_λ^{31} | $\rho(\tilde{X}_\lambda^{31})$ | singular fibers of $\tilde{\varphi}_\lambda^{d_6}$ | MW($\tilde{\varphi}_\lambda^{d_6}$) |
|---------------------------|--|-----------------------------------|--------------------------------|---|---------------------------------------|
| $\neq \lambda_k, -8/17$ | \emptyset | $D_6 + A_3 + 3A_2 + 2A_1$ | $\geq 18^{(\dagger)}$ | $\tilde{D}_7 + 3\tilde{A}_2 + 3\tilde{A}_1$ | $0^{(\ddagger)}$ |
| $-8/17$ | \emptyset | $D_6 + A_3 + 3A_2 + 2A_1$ | 19 | $\tilde{D}_7 + \tilde{A}_4 + 2\tilde{A}_2 + 2\tilde{A}_1$ | 0 |
| $\lambda_{145} = -8/25$ | $960A_1$ | $D_6 + D_5 + A_3 + 2A_2$ | 19 | $\tilde{D}_7 + \tilde{D}_5 + 2\tilde{A}_2 + \tilde{A}_1$ | 0 |
| $\lambda_{245} = -81/175$ | $480A_1$ | $E_6 + D_6 + A_3 + A_2 + A_1$ | 19 | $\tilde{E}_6 + \tilde{D}_7 + \tilde{A}_2 + 2\tilde{A}_1$ | 0 |
| $\lambda_1 = 1$ | $1920A_1$ | $D_6 + A_5 + A_3 + A_2 + 2A_1$ | 19 | $\tilde{D}_7 + \tilde{A}_5 + \tilde{A}_2 + 3\tilde{A}_1$ | $\mathbb{Z}/2\mathbb{Z}$ |
| $\lambda_2 = -1/3$ | $1440A_2$ | $D_6 + D_5 + 3A_2 + A_1$ | 19 | $\tilde{D}_9 + 3\tilde{A}_2 + 2\tilde{A}_1$ | 0 |
| $\lambda_3 = -1/2$ | $640A_3$ | $D_6 + 2A_3 + 2A_2 + 2A_1$ | 19 | $\tilde{D}_7 + \tilde{D}_5 + 2\tilde{A}_2 + \tilde{A}_1$ | 0 |

TABLE IV. Some numerical data for the family of K3 surfaces $(\tilde{X}_\lambda^{31})_{\lambda \in \mathbb{C}^\times}$ ^(†) With equality for λ generic^(‡) Only for λ generic

7.4.1. *The case $\lambda = -8/17$.* We assume here, and only here, that $\lambda = -8/17$. As shown in Proposition 7.6, the elliptic fibration $\varphi_{-8/17}^{d_6}$ of the K3 surface $X_{-8/17}^{31}$ has the property that Δ_λ contains a singular point of $X_{-8/17}^{31}$ different from d_6 and the corresponding singular fiber $\mathcal{E}_{-8/17}$ is of type \tilde{A}_4 . This has the following consequence for its Picard number, which makes $\tilde{X}_{-8/17}^{31}$ a special member of the family obtained from minimal resolutions of quotients by G'_{31} of the smooth family of icosahedra $(\mathcal{Z}(f_{3,\lambda}))_{\lambda \in \mathbb{C}^\times \setminus \{\lambda_{145}, \lambda_{245}, \lambda_1, \lambda_2, \lambda_3\}}$:

Proposition 7.8. $\rho(\tilde{X}_{-8/17}^{31}) = 19$.

Proof. For proving that $\rho(X_{-8/17}^{31}) \geq 19$, we shall use the elliptic fibration $\tilde{\varphi}_\lambda^{d_6}$. Indeed, this fibration admits a section, so $\rho(X_{-8/17}^{31}) \geq 2 + m'$, where m' is the rank of the subgroup of $\text{Pic}(X_{-8/17}^{31})$ generated by irreducible components of the singular fibers (here, 2 comes from the section and a general smooth fiber of $\tilde{\varphi}_\lambda^{d_6}$). It follows from Table IV that $m' = 17$, so

$$\rho(\tilde{X}_{-8/17}^{31}) \geq 19.$$

Now, proving that $\rho(\tilde{X}_{-8/17}^{31}) = 19$ is done as in the proof of Corollary 6.16, thanks to MAGMA computations and the Artin-Tate Conjecture. \square

7.4.2. *The case $\lambda = \lambda_1 = 1$.* We assume here, and only here, that $\lambda = \lambda_1 = 1$. We set

$$q_1 = z_1 z_2 - 1/108 z_2^2 + 1/54 z_2 z_4 - 1/108 z_4^2$$

and $c_1 = z_1^2 z_2 - 54 z_1 z_2^2 + 1/8 z_1^2 z_4 - 9 z_1 z_2 z_4 - 1/4 z_1 z_4^2 + 1/8 z_4^3$.

Then q_1 and c_1 are irreducible and

$$r_1 = -864q_1c_1.$$

So, if we denote by $Q_1 = \mathcal{Z}(q_1)$ and $C_1 = \mathcal{Z}(c_1)$, then Q_1 is a smooth conic while C_1 is a cuspidal cubic. Then

$$(7.9) \quad R_1 = \bar{B}_2 \cup Q_1 \cup C_1.$$

The singular points of R_1 are given by

$$d_6 = [1 : 0 : 0], \quad a_3 = [1 : 0 : 1], \quad a_5 = [1 : 3 : 21], \quad a_2 = [1 : 1/27 : -1/3],$$

$$a_1^+ = [1 : \frac{231\sqrt{33}+1327}{2}, \frac{165\sqrt{33}+949}{2}] \quad \text{and} \quad a_1^- = [1 : \frac{-231\sqrt{33}+1327}{2}, \frac{-165\sqrt{33}+949}{2}].$$

It is easily checked that

$$d_6 \in \bar{B}_2 \cap Q_1 \cap C_1, \quad a_3 \in (\bar{B}_2 \cap C_1) \setminus Q_1,$$

$$a_2 \in C_1 \setminus (\bar{B}_2 \cup Q_1), \quad a_5, a_1^\pm \in (Q_1 \cap C_1) \setminus \bar{B}_2.$$

We denote by Q'_1 the preimage of Q_1 in X_1^{31} , endowed with its reduced structure (so that $Q'_1 \simeq Q_1$) and we denote by \tilde{Q}'_1 the strict transform of Q'_1 in \tilde{X}_1^{31} . Since Q'_1 is a smooth rational curve, we get that

$$(7.10) \quad \tilde{Q}'_1 \simeq Q'_1 \simeq Q_1.$$

Since the smooth conic Q_1 goes through the point d_6 , we get that \tilde{Q}'_1 is a section of the elliptic fibration $\tilde{\varphi}_1^{d_6}$. By Table IV, we get:

Proposition 7.11. *The smooth rational curve \tilde{Q}'_1 is a section of the elliptic fibration $\tilde{\varphi}_1^{d_6}$. It is 2-torsion and generates the Mordell-Weil group $\text{MW}(\tilde{\varphi}_1^{d_6})$.*

7.4.3. *The case $\lambda = \lambda_3 = -1/2$.* We assume here, and only here, that $\lambda = -1/2$. We set

$$r_{-1/2}^\circ = 27z_1^3z_2 + 947/16z_1^2z_2^2 + 54z_1z_2^3 - 113/2z_1^2z_2z_4$$

$$- 171/2z_1z_2^2z_4 - z_1^2z_4^2 + 59/2z_1z_2z_4^2 + 2z_1z_4^3 + z_2z_4^3 - z_4^4$$

Then $r_{-1/2}^\circ$ is irreducible and

$$(7.12) \quad r_{-1/2} = (z_2 - z_4)r_{-1/2}^\circ.$$

Let L denote the line in $\mathbb{P}^2(\mathbb{C})$ defined by $\mathcal{Z}(z_2 - z_4)$ and let $R_{-1/2}^\circ = \mathcal{Z}(r_{-1/2}^\circ) \subset R_{-1/2}$. Then

$$(7.13) \quad R_{-1/2} = \bar{B}_2 \cup L \cup R_{-1/2}^\circ.$$

The singular points of $R_{-1/2}$ are

$$d_6 = [1 : 0 : 0], \quad a_3 = [1 : 0 : 1], \quad a_3^L = [0 : 1 : 1],$$

$$a_2^+ = [1 : \frac{52\sqrt{13}-184}{27} : \frac{13\sqrt{13}-37}{6}], \quad a_2^- = [1 : \frac{-52\sqrt{13}-184}{27} : \frac{-13\sqrt{13}-37}{6}],$$

$$a_1^L = [1 : -16 : -16] \quad \text{and} \quad a_1 = [1 : 1/32 : 7/8],$$

With this notation, d_6 is a D_6 singularity, a_3 and a_3^L are A_3 singularities, a_2^+ and a_2^- are A_2 singularities and a_1 and a_1^L are A_1 singularities of $R_{-1/2}$. Note that, as sets,

$$(7.14) \quad \bar{B}_2 \cap L = \{d_6\}, \quad \bar{B}_2 \cap R_{-1/2}^\circ = \{d_6, a_3\} \quad \text{and} \quad L \cap R_{-1/2}^\circ = \{d_6, a_3^L, a_1^L\}.$$

Let L' denote the preimage of L in $X_{-1/2}^{31}$ endowed with its reduced structure. Then

$$L' = \{[z_1 : z_2 : z_3 : t] \in \mathbb{P}(1, 1, 1, 3) \mid t = z_2 - z_4 = 0\} \simeq \mathbb{P}^1(\mathbb{C}).$$

We denote by \tilde{L}' its strict transform in $\tilde{X}_{-1/2}^{31}$. Then $(\tilde{\varphi}_{-1/2}^{d_6})^{-1}(\varphi_\lambda(a_3))$ contains $\Delta_6^{d_6}$, \tilde{L}' and the exceptional divisors above the singularities \hat{a}_1^L and \hat{a}_3^L : the smooth rational curve \tilde{L}' meets $\Delta_6^{d_6}$, the exceptional divisor above \hat{a}_1^L and at least one of the exceptional divisors above \hat{a}_3^L , so the only possibility is that $(\tilde{\varphi}_{-1/2}^{d_6})^{-1}(\varphi_\lambda(a_3))$ is a singular fiber of type \tilde{D}_5 .

The other singular fibers are now determined easily and fit with the data in Table IV. Note also that \tilde{L}' provides another section of all the fibrations $\tilde{\varphi}_{-1/2}^{a_1}$, $\tilde{\varphi}_{-1/2}^{a_2^\pm}$ and $\tilde{\varphi}_{-1/2}^{a_3}$.

Appendix: Morphisms to $\mathbb{P}^1(\mathbb{C})$

We describe here two basic constructions of morphisms to $\mathbb{P}^1(\mathbb{C})$ which are used in the body of the article for constructing elliptic fibrations on our K3 surfaces.

A. WEIGHTED PROJECTIVE SPACE

Notation. We fix two natural numbers k and l such that $\gcd(k, l) = 1$, we set $m = k + l$ and we denote here by p the point $[0 : 0 : 1]$ of $\mathbb{P}(k, l, m)$. It is an A_{m-1} -singularity of $\mathbb{P}(k, l, m)$. We denote by $\pi : \hat{\mathbb{P}}(k, l, m) \rightarrow \mathbb{P}(k, l, m)$ the minimal resolution of the singularity p .

Note that we have only resolved the singularity p , so that $\pi^{-1}(\mathbb{P}(k, l, m) \setminus \{p\})$ may still have two singular points (above $[1 : 0 : 0]$ and $[0 : 1 : 0]$). Let

$$\begin{aligned} \varphi_{k,l} : \mathbb{P}(k, l, m) \setminus \{p\} &\longrightarrow \mathbb{P}^1(\mathbb{C}) \\ [x : y : z] &\longmapsto [x^l : y^k]. \end{aligned}$$

Then there exists a unique morphism of varieties

$$\hat{\varphi}_{k,l} : \hat{\mathbb{P}}(k, l, m) \longrightarrow \mathbb{P}^1(\mathbb{C})$$

making the diagram

$$(A.1) \quad \begin{array}{ccc} \hat{\mathbb{P}}(k, l, m) \setminus \pi^{-1}(p) & \xrightarrow{\quad} & \hat{\mathbb{P}}(k, l, m) \\ \downarrow \pi \wr & & \downarrow \hat{\varphi}_{k,l} \\ \mathbb{P}(k, l, m) \setminus \{p\} & \xrightarrow{\quad \varphi_{k,l} \quad} & \mathbb{P}^1(\mathbb{C}) \end{array}$$

commutative.

Proof. The uniqueness is trivial, so let us prove the existence. It is sufficient to work in the affine chart $U_z = \{[x : y : z] \in \mathbb{P}(k, l, m) \mid z \neq 0\}$ of $\mathbb{P}(k, l, m)$. We denote by \tilde{U}_z its minimal resolution of singularities. Through the variables $a = x^m$, $b = xy$ and $c = y^m$ (and setting $z = 1$), we have

$$U_z = \{(a, b, c) \in \mathbb{A}^3(\mathbb{C}) \mid b^m = ac\}$$

and p corresponds to the point 0 of U_z while the restriction of $\varphi_{k,l}$ to $U_z \setminus \{0\}$ is given by

$$\varphi_{k,l}(a, b, c) = \begin{cases} [a : b^k] & \text{if } (a, b) \neq (0, 0), \\ [b^l : c] & \text{if } (b, c) \neq (0, 0). \end{cases}$$

A model for the minimal resolution of U_z is given by⁵

$$\tilde{U}_z = \{((a, b, c), [u_1 : u_2 : \dots : u_m]) \in U_z \times \mathbb{P}^{m-1}(\mathbb{C}) \mid \begin{cases} \forall 2 \leq j \leq m, au_j = b^{j-1}u_{j-1}, \\ \forall 1 \leq j \leq m-1, cu_j = b^{m-j}u_{j+1}, \\ \forall 1 \leq j < j' \leq m, u_j u_{j'} = b^{j'-j-1}u_{j+1}u_{j'-1} \end{cases} \}.$$

Note that the last equation is automatically fulfilled if $j' = j + 1$.

We then define $\hat{\varphi}_{k,l} : \tilde{U}_z \rightarrow \mathbb{P}^1(\mathbb{C})$ by

$$(A.2) \quad \hat{\varphi}_{k,l}((a, b, c), [u_1 : u_2 : \dots : u_m]) = \begin{cases} [u_j : b^{k-j}u_{j+1}] & \text{if } u_j \neq 0 \text{ and } j \leq k, \\ [b^{j-1-k}u_{j-1} : u_j] & \text{if } u_j \neq 0 \text{ and } j \geq k+1. \end{cases}$$

An immediate computation from the equations of U_z shows that $\hat{\varphi}_{k,l}$ is well-defined and satisfies the required property. \square

Let $\Delta_1, \dots, \Delta_{m-1}$ be the smooth projective lines in the exceptional divisor $\pi^{-1}(p)$ and we assume that they are numbered so that, in the open subset \tilde{U}_z described in the proof of (A.1),

$$\Delta_j = \{0\} \times \{[u_1 : \dots : u_m] \in \mathbb{P}^{m-1}(\mathbb{C}) \mid \forall r \in \{1, 2, \dots, m\} \setminus \{j, j+1\}, u_r = 0\}.$$

Let

$$\Delta_x = \{[x : y : z] \in \mathbb{P}(k, l, m) \mid x = 0\} \quad \text{and} \quad \Delta_y = \{[x : y : z] \in \mathbb{P}(k, l, m) \mid y = 0\}.$$

Then Δ_x and Δ_y are smooth rational curves and $\Delta_x \cap \Delta_y = \{p\}$. Let $\tilde{\Delta}_x$ and $\tilde{\Delta}_y$ denote the respective strict transforms of Δ_x and Δ_y in $\hat{\mathbb{P}}(k, l, m)$.

Proposition A.3. *The fiber $\hat{\varphi}_{k,l}^{-1}([1 : 0])$ (resp. $\hat{\varphi}_{k,l}^{-1}([0 : 1])$) is the union of the smooth rational curves $\tilde{\Delta}_y, \Delta_1, \dots, \Delta_{k-1}$ (resp. $\Delta_{k+1}, \dots, \Delta_{m-1}, \tilde{\Delta}_x$). The intersection graphs are given respectively by*

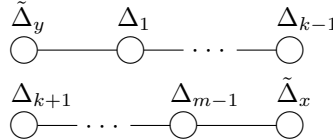

and

⁵For $0 \leq j \leq m-1$, let J_j denote the ideal of the algebra $\mathbb{C}[U_z] = \mathbb{C}[A, B, C]/\langle B^m - AC \rangle$ generated by A and B^j . Then \tilde{U}_z is the blowing-up of $J_0 J_1 \dots J_{m-1} = \langle (A^{m-j} B^{j(j-1)/2})_1 \mid 1 \leq j \leq m \rangle$: the variable u_j corresponds to the generator $A^{m-j} B^{j(j-1)/2}$.

Proof. One only needs to determine the intersections of the fibers $\hat{\varphi}_{k,l}^{-1}([1 : 0])$ and $\hat{\varphi}_{k,l}^{-1}([0 : 1])$ with the open set \tilde{U}_z of $\hat{\mathbb{P}}(k, l, m)$. But this can be done from the explicit model and formula (A.2) given in the proof of (A.1). \square

Remark A.4. It follows from (A.2) that the restriction of $\hat{\varphi}_{k,l}$ to the smooth rational curve Δ_k is an isomorphism: this provides a section $\mathbb{P}^1(\mathbb{C}) \rightarrow \hat{\mathbb{P}}(k, l, m)$ to the morphism $\hat{\varphi}_{k,l} : \hat{\mathbb{P}}(k, l, m) \rightarrow \mathbb{P}^1(\mathbb{C})$. \blacksquare

Remark A.5. Let $p \in \mathbb{P}^1(\mathbb{C}) \setminus \{[1 : 0], [0 : 1]\}$. Then $\overline{\varphi_{k,l}^{-1}(p)}$ is a smooth rational curve. Indeed, write $p = [1 : \alpha]$ with $\alpha \neq 0$ (and assume that $k \leq l$, the other case being similar). Then

$$\overline{\varphi_{k,l}^{-1}(p)} = \{[x : y : z] \in \mathbb{P}(k, l, m) \mid y^k = \alpha x^l\}.$$

Working first in the affine chart U_z , we get

$$\overline{\varphi_{k,l}^{-1}(p)} \cap U_z = \{(a, b, c) \in \mathbb{A}^3(\mathbb{C}) \mid b^m = ac, c = \alpha b^l \text{ and } a = \alpha^{-1} b^k\} \simeq \mathbb{A}^1(\mathbb{C}).$$

Working now in the affine chart $U_x = \{[x : y : z] \in \mathbb{P}(k, l, m) \mid x \neq 0\}$, we have

$$U_x = \{(u_0, u_1, \dots, u_k) \in \mathbb{A}^{k+1}(\mathbb{C}) \mid \forall 1 \leq j \leq j' \leq k, v_j v_{j'} = v_{j-1} v_{j'+1}\}$$

(here, the variable v_j stands for $y^j z^{k-j}$). Therefore,

$$\overline{\varphi_{k,l}^{-1}(p)} \cap U_x = \{(u_0, u_1, \dots, u_k) \in U_x \mid u_0 = \alpha\} \simeq \mathbb{A}^1(\mathbb{C}),$$

the isomorphism $\mathbb{A}^1(\mathbb{C}) \xrightarrow{\sim} \overline{\varphi_{k,l}^{-1}(p)} \cap U_x$ being given by $u \mapsto \alpha(1, u, u^2, \dots, u^{k-1})$.

Since $\overline{\varphi_{k,l}^{-1}(p)}$ is contained in $U_x \cup U_z$, we conclude that $\overline{\varphi_{k,l}^{-1}(p)}$ is a smooth rational curve. \blacksquare

B. DOUBLE COVER OF $\mathbb{P}^2(\mathbb{C})$

Hypothesis and notation. We fix a non-zero natural number m and a square-free homogeneous polynomial $F \in \mathbb{C}[a, b, c]$ of degree $2m$, where a, b and c are of degree 1. We denote by \mathcal{X} the surface

$$\mathcal{X} = \{[a : b : c : t] \in \mathbb{P}(1, 1, 1, m) \mid t^2 = F(a, b, c)\}$$

and by $\xi : \mathcal{X} \rightarrow \mathbb{P}^2(\mathbb{C})$, $[a : b : c : t] \mapsto [a : b : c]$. Let σ denote the involutive automorphism of $\mathbb{P}(1, 1, 1, m)$ defined by $\sigma([a : b : c : t]) = [a : b : c : -t]$.

Then σ stabilizes \mathcal{X} and ξ is the double cover of $\mathbb{P}^2(\mathbb{C})$ associated with σ . We denote by $\mathcal{R} \subset \mathbb{P}^2(\mathbb{C})$ its branch locus

$$\mathcal{R} = \{[a : b : c] \in \mathbb{P}^2(\mathbb{C}) \mid F(a, b, c) = 0\}.$$

If $x = [a : b : c] \in \mathcal{R}$, we denote by $\hat{x} = [a : b : c : 0]$ its unique preimage in \mathcal{X} . We also define $p_x : \mathbb{P}^2(\mathbb{C}) \setminus \{x\} \rightarrow \mathbb{P}^1(\mathbb{C})$ to be the projection from x

and let $\beta_x : \hat{\mathbb{P}}_x^2(\mathbb{C}) \rightarrow \mathbb{P}^2(\mathbb{C})$ denote the blow-up of $\mathbb{P}^2(\mathbb{C})$ at x . Then the map $p_x \circ \beta_x : \hat{\mathbb{P}}_x^2(\mathbb{C}) \setminus \beta_x^{-1}(x) \rightarrow \mathbb{P}^1(\mathbb{C})$ extends uniquely to a morphism

$$\hat{p}_x : \hat{\mathbb{P}}_x^2(\mathbb{C}) \rightarrow \mathbb{P}^1(\mathbb{C}),$$

which admits a section $\hat{s}_x : \mathbb{P}^1(\mathbb{C}) \rightarrow \hat{\mathbb{P}}_x^2(\mathbb{C})$ whose image is $\beta_x^{-1}(x) \simeq \mathbb{P}^1(\mathbb{C})$. Finally, we denote by $\pi_x : \hat{\mathcal{X}}_x \rightarrow \mathcal{X}$ the blow-up of \mathcal{X} at \hat{x} .

Proposition B.1. *Assume that x is a singular point of the branch locus \mathcal{R} . Then the morphism $\xi : \mathcal{X} \rightarrow \mathbb{P}^2(\mathbb{C})$ lifts uniquely to a morphism $\hat{\xi}_x : \hat{\mathcal{X}}_x \rightarrow \hat{\mathbb{P}}_x^2(\mathbb{C})$ making the diagram*

$$\begin{array}{ccc} \hat{\mathcal{X}}_x & \xrightarrow{\hat{\xi}_x} & \hat{\mathbb{P}}_x^2(\mathbb{C}) \\ \pi_x \downarrow & & \downarrow \beta_x \\ \mathcal{X} & \xrightarrow{\xi} & \mathbb{P}^2(\mathbb{C}) \end{array}$$

commutative.

Remark B.2. The reader can easily check that, if x is not a singular point of R , then the conclusion of proposition fails. ■

Proof. The uniqueness is clear, we only need to show the existence. By a linear change on the coordinates a, b, c , we may assume that $x = [0 : 0 : 1]$. It is sufficient to work in the open subsets \mathcal{U} and U of \mathcal{X} and $\mathbb{P}^2(\mathbb{C})$ defined by $c \neq 0$ (and we denote by $\hat{\mathcal{U}}_x$ and \hat{U}_x their respective blow-up at \hat{x} and x). We set $F_c(a, b) = F(a, b, 1)$. Then, since x is a singular point of R , this means that $F_c(0, 0) = 0$ and that the homogeneous component of degree 1 of F_c is zero. We can then write uniquely

$$F_c(a, b) = a^2\lambda(a, b) + ab\mu(b) + b^2\nu(b)$$

with $\lambda \in \mathbb{C}[a, b]$ and $\mu, \nu \in \mathbb{C}[b]$. Therefore:

$$\begin{aligned} \hat{\mathcal{U}}_x &= \{((a, b, t), [A : B : T]) \in \mathbb{A}^3(\mathbb{C}) \times \mathbb{P}^2(\mathbb{C}) \mid (a, b, t) \in [A : B : T] \\ &\quad \text{and } T^2 = A^2\lambda(a, b) + AB\mu(b) + B^2\nu(b)\} \end{aligned}$$

and $\hat{U}_x = \{((a, b), [A : B]) \in \mathbb{A}^2(\mathbb{C}) \times \mathbb{P}^1(\mathbb{C}) \mid (a, b) \in [A : B]\}$.

Then the map $\hat{\xi}_x : \hat{\mathcal{U}}_x \rightarrow \hat{U}_x$ defined by

$$\hat{\xi}_x((a, b, t), [A : B : T]) = ((a, b), [A : B])$$

is well-defined and satisfies the requirements of the proposition. \square

Proposition B.1 allows to define a morphism

$$\hat{\varphi}_x = \hat{\rho}_x \circ \hat{\xi}_x : \hat{\mathcal{X}}_x \longrightarrow \mathbb{P}^1(\mathbb{C}).$$

We now investigate the question of sections of this morphism, whenever x is an ADE singularity of the branch locus \mathcal{R} (by [5, Proposition 4.4], this implies that \hat{x} is a simple singularity of the surface \mathcal{X} of the same type as x). First, note that, if $s_x : \mathbb{P}^1(\mathbb{C}) \longrightarrow \hat{\mathcal{X}}_x$ is a section of $\hat{\varphi}_x$, then $\hat{\xi}_x \circ s_x$ is a section of $\hat{\rho}_x$. Therefore, the question amounts to study sections of the morphism $\hat{\xi}_x : \pi_x^{-1}(\hat{x}) \longrightarrow \beta_x^{-1}(x) \simeq \mathbb{P}^1(\mathbb{C})$. Here, we endow $\pi_x^{-1}(\hat{x})$ with its reduced structure. A first answer is given in the next proposition:

Proposition B.3. *Let x be an ADE singularity of \mathcal{R} . Then:*

- (a) *If x is an A_1 singularity, then $\pi_x^{-1}(\hat{x}) \simeq \mathbb{P}^1(\mathbb{C})$ and the morphism $\hat{\xi}_x : \pi_x^{-1}(\hat{x}) \longrightarrow \beta_x^{-1}(x)$ is a double cover admitting no section.*
- (b) *If x is an A_m singularity with $m \geq 2$, then $\pi_x^{-1}(\hat{x})$ is the union of two smooth rational curves ($\simeq \mathbb{P}^1(\mathbb{C})$) intersecting transversally at one point, and both smooth rational curves map isomorphically to $\beta_x^{-1}(x)$. This gives two sections of $\hat{\xi}_x$, each one being obtained from the other by composing with the involution σ .*
- (c) *If x is a DE singularity, then $\pi_x^{-1}(\hat{x}) \simeq \mathbb{P}^1(\mathbb{C})$ mapping isomorphically on $\beta_x^{-1}(x)$. This gives one section of $\hat{\xi}_x$.*

Proof. As in the proof of the previous Proposition B.1, we may assume that $x = [0 : 0 : 1]$ and we keep the notation introduced in this above proof. In particular,

$$\pi_x^{-1}(\hat{x}) \simeq \{[A : B : T] \in \mathbb{P}^2(\mathbb{C}) \mid T^2 = \alpha(0,0)A^2 + \beta(0)AB + \gamma(0)B^2\}$$

and $\hat{\xi}_x([A : B : T]) = [A : B]$. Let us examine the different cases.

(a) If x is an A_1 singularity, then a linear change of coordinates in a, b allows to assume that $\alpha(0,0) = \gamma(0) = 0$ and $\beta(0) = 1$. Then

$$\pi_x^{-1}(\hat{x}) \simeq \{[A : B : T] \in \mathbb{P}^2(\mathbb{C}) \mid T^2 = AB\}$$

and the result follows.

(b) If x is an A_m singularity with $m \geq 2$, then a linear change of coordinates in a, b allows to assume that $\alpha(0,0) = 1$ and $\beta(0) = \gamma(0) = 0$. Then

$$\pi_x^{-1}(\hat{x}) \simeq \{[A : B : T] \in \mathbb{P}^2(\mathbb{C}) \mid T^2 = A^2\} = \Delta_+ \cup \Delta_-,$$

where $\Delta_{\pm} = \{[A : B : T] \in \mathbb{P}^2(\mathbb{C}) \mid A = \pm T\}$. The result follows.

(c) If x is a DE singularity, then $\alpha(0,0) = \beta(0) = \gamma(0) = 0$, so

$$\pi_x^{-1}(\hat{x}) \simeq \{[A : B : T] \in \mathbb{P}^2(\mathbb{C}) \mid T = 0\} \simeq \mathbb{P}^1(\mathbb{C}),$$

so the result follows. \square

Let us go on with the case where x is an ADE singularity of \mathcal{R} . We denote by $\tilde{\pi}_x : \tilde{\mathcal{X}}_x \longrightarrow \mathcal{X}$ the resolution of \mathcal{X} only at the point \hat{x} . It factorizes through $\hat{\mathcal{X}}_x \longrightarrow \tilde{\mathcal{X}}_x \longrightarrow \mathcal{X}$. Let m denote the Milnor number of \hat{x} . Then $\tilde{\pi}_x^{-1}(\hat{x})$ is the union of m smooth rational curves whose intersection graph is denoted by Γ_x . If x is not of type A_1 , we denote by $\Gamma_x^{\#}$ the graph obtained from Γ_x by removing

the smooth rational curves which are mapped isomorphically to $\mathbb{P}^1(\mathbb{C})$ under $\hat{\varphi}_x$. According to the discussion of Proposition B.3, easy computations give the following consequences about the behaviour of $\hat{\varphi}_x$ and the action of σ on the corresponding intersection graph (here, type D_2 means type $A_1 \times A_1$ and type D_3 coincides with type A_3):

Corollary B.4. *All the smooth rational curves belonging to the same connected component of $\Gamma_x^\#$ are mapped to the same point of $\mathbb{P}^1(\mathbb{C})$ under $\hat{\varphi}_x$. If two smooth rational curves do $\Gamma_x^\#$ do not belong to the same connected component, then they are mapped to different points of $\mathbb{P}^1(\mathbb{C})$ under $\hat{\varphi}_x$. Moreover:*

- (a) *If x is an A_1 singularity, then $\hat{\varphi}_x : \Delta_1^x \rightarrow \mathbb{P}^1(\mathbb{C})$ is a double cover corresponding to the quotient by the action of σ .*
- (b) *If x is an A_m singularity with $m \geq 2$, then $\Gamma_x^\#$ is of type A_{m-2} and σ acts on Γ_x by the unique non-trivial involutive automorphism.*
- (c) *If x is a D_m singularity with $m \geq 4$, then $\Gamma_x^\#$ is of type $D_{m-2} \times A_1$. Moreover, σ acts on the intersection graph as the identity if m is even and as the unique non-trivial involutive automorphism if m is odd.*
- (d) *If x is an E_6 singularity, then $\Gamma_x^\#$ is of type A_5 and σ acts on Γ_x as the unique non-trivial involutive automorphism.*
- (e) *If x is an E_7 (resp. E_8) singularity, then $\Gamma_x^\#$ is of type D_6 (resp. E_7) and σ acts on Γ_x as the identity.*

REFERENCES

1. W. Barth and A. Sarti, *Polyhedral groups and pencils of K3-surfaces with maximal Picard number*, Asian J. Math. **7** (2003).
2. S. Boissière and A. Sarti, *Counting lines on surfaces*, Ann. Sc. Norm. Super. Pisa Cl. Sci. (5) **6** (2007).
3. C. Bonnafé, *Some Singular Curves and Surfaces Arising from Invariants of Complex Reflection Groups*, Exp. Math. **30** (2021), no. 3, 429–440.
4. C. Bonnafé, *Magma codes for "Some singular curves and surfaces arising from invariants of complex reflection groups"*, preprint (2018), hal-01897587.
5. C. Bonnafé and A. Sarti, *Complex reflection groups and K3 surfaces I*, Épijournal Géom. Algébrique **5** (2021), Art. 3, 26.
6. C. Bonnafé and A. Sarti, *Complex reflection groups and K3 surfaces III. The group $G_{28} = W(F_4)$* , to come.
7. ———, *Magma codes for "complex reflection groups and K3 surfaces II"*, to come.
8. Cédric Bonnafé and Alessandra Sarti, *K3 surfaces with maximal finite automorphism groups containing m_{20}* , Annales de l'Institut Fourier **71** (2021), no. 2, 711–730.
9. W. Bosma, J. Cannon, and C. Playoust, *The Magma algebra system. I. The user language*, J. Symbolic Comput. **24** (1997), Computational algebra and number theory (London, 1993).
10. N. Bourbaki, *Groupes et algèbres de Lie, Chapitres 4, 5, 6*, Actualités Scientifiques et Industrielles **1337**, Hermann, Paris, 1968.
11. A. Degtyarev, *800 conics in a smooth quartic surface*, preprint (2021), arxiv:2102.08163.
12. A.-S. Elsenhans and J. Jahnel, *The Picard group of a K3 surface and its reduction modulo p* , Algebra Number Theory **5** (2011), no. 8, 1027–1040.
13. D. Festi and D. C. Veniani, *Counting elliptic fibrations on k3 surfaces*, preprint (2021).
14. H. Inose, *On certain Kummer surfaces which can be realized as non-singular quartic surfaces in \mathbb{P}^3* , J. Fac. Sci. Univ. Tokyo Sect. IA Math. **23** (1976).
15. G. Lusztig, *Some examples of square integrable representations of semisimple p -adic groups*, Trans. Amer. Math. Soc. **277** (1983).
16. I. Marin and J. Michel, *Automorphisms of complex reflection groups*, Represent. Theory **14** (2010), 747–788.

17. J. Michel, *The development version of the chevie package of gap3*, J. Algebra **435** (2015), 308–336.
18. S. Mukai, *Finite groups of automorphisms of K3 surfaces and the Mathieu group*, Invent. Math. **94** (1988).
19. B. Naskręcki, *Explicit equations of 800 conics on a Barth-Bauer quartic*, 2021, [arxiv:2108.13402](https://arxiv.org/abs/2108.13402).
20. N. Nygaard and A. Ogus, *Tate's conjecture for K3 surfaces of finite height*, Ann. of Math. (2) **122** (1985), no. 3, 461–507.
21. A. Sarti, *Pencils of symmetric surfaces in \mathbb{P}^3* , J. Algebra **246** (2001).
22. ———, *Transcendental lattices of some K3-surfaces*, Math. Nachr. **281** (2008).
23. Matthias Schütt, *Elliptic fibrations of some extremal K3 surfaces*, Rocky Mountain J. Math. **37** (2007), no. 2, 609–652.
24. Matthias Schütt and Tetsuji Shioda, *Mordell-Weil lattices*, Ergebnisse der Mathematik und ihrer Grenzgebiete. 3. Folge. A Series of Modern Surveys in Mathematics [Results in Mathematics and Related Areas. 3rd Series. A Series of Modern Surveys in Mathematics], vol. 70, Springer, Singapore, 2019.
25. G. C. Shephard and J. A. Todd, *Finite unitary reflection groups*, Canadian J. Math. **6** (1954), 274–304.
26. I. Shimada, *On elliptic K3 surfaces*, Michigan Math. J. **47** (2000), no. 3, 423–446.
27. H. Sterk, *Finiteness results for algebraic K3 surfaces*, Math. Z. **189** (1985).
28. U. Thiel, *Champ: a Cherednik algebra Magma package*, LMS J. Comput. Math. **18** (2015).
29. R. van Luijk, *Quartic K3 surfaces without nontrivial automorphisms*, Math. Res. Lett. **13** (2006), no. 2-3, 423–439.
30. ———, *K3 surfaces with Picard number one and infinitely many rational points*, Algebra Number Theory **1** (2007), no. 1, 1–15.
31. G. Xiao, *Galois covers between K3 surfaces*, Ann. Inst. Fourier (Grenoble) **46** (1996).

IMAG, UNIVERSITÉ DE MONTPELLIER, CNRS, MONTPELLIER, FRANCE
Email address: cedric.bonnafe@umontpellier.fr
URL: <http://imag.umontpellier.fr/~bonnafe/>

UNIVERSITÉ DE POITIERS, LABORATOIRE DE MATHÉMATIQUES ET APPLICATIONS, UMR 7348
 CNRS, TSA 61125, 11 BD MARIE ET PIERRE CURIE, 86073 POITIERS CEDEX 9, FRANCE
Email address: sarti@math.univ-poitiers.fr
URL: <http://www-math.sp2mi.univ-poitiers.fr/~sarti/>